

# No. 21500558 PEUGEOT

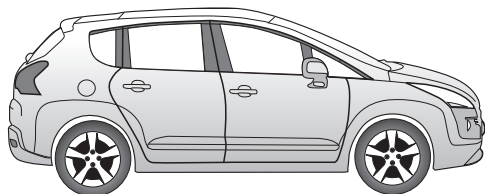

3008

06/09 →

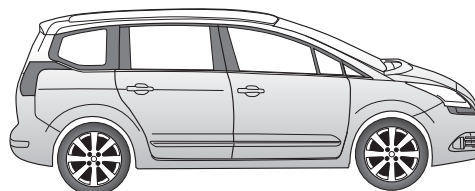

5008

10/09 →

**SK**

Elektrosada pre ťažné zariadenie / 13-pól / 12 Volt / ISO 11446

## Návod na použitie

**PL**

Zestaw elektryczny do haka holowniczego / 13-biegunowy / 12 Volt / ISO 11446

## Instrukcja montażu

**D**

Elektro-Einbausatz für Anhängerkupplung / 13-polig / 12 Volt / ISO 11446

## Einbauanleitung

**GB**

Electric wiring kit for towbars / 13-pin / 12 Volt / ISO 11446

## Fitting instructions

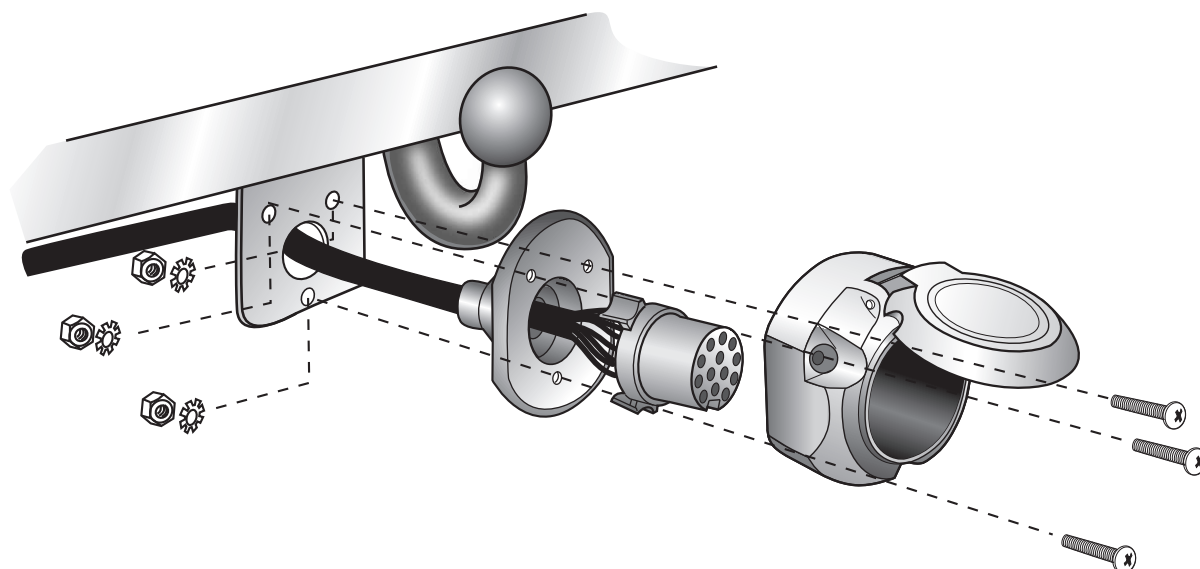

**POZOR!**

Montaz tejto elektrosady musí byť prevedená v špecializovanom servise alebo primerane kvalifikovanou osobou. Pred začatím montáže je nutné dôkladne si prečítať návod na použitie. Po ukončení montáže je potrebné tento návod odložiť ku servisným dokumentom vozidla.

Pri neodbornej montáži alebo zmene elektrosady, prípadne zmene existujúcich súčiastok, zanika akýkoľvek nárok na záruku. Pri jazde bez príviesu je nutné odpojiť adapter zo zásuvky (ak je tento v prevádzke). Zmeny týkajúce sa konštrukcie, vybavenia, farieb, ako aj omyly sú vyhradené. Všetky špecifikácie a ilustrácie sú nezáväzná.

Ak prívies nie je vybavený hmlovým svetlom, je potrebné ho dodatočne namontovať.

Za technické zmeny, prípadne zmeny elektroniky, ktoré boli uskutočnené výrobcom vozidla po uvedení elektrosady do prevádzky, a ktoré vedú k chybným funkciám zásuvky alebo prídavných zariadení, nepreberáme žiadnu záruku.

Modul príviesu nie je schopný komunikovať s diagnostickým zariadením. V prípade, že testovacie mechanizmy generujú chybný protokol pri diagnostike, súvisiaci s tým priamo alebo nepriamo s prevádzkou príviesu, je nutné odpojiť modul príviesu od elektrosady a opakovane vykonať diagnostiku.

**UWAGA!**

Przed rozpoczęciem montażu wiązki elektrycznej należy dokładnie zapoznać się z dołączoną instrukcją. Po zamontowaniu wiązki do samochodu instrukcje montażu należy dołączyć do dokumentacji samochodu. Montaż wiązki elektrycznej musi być przeprowadzony przez specjalistyczny warsztat samochodowy. Montaż wiązki przez osoby niewykwalifikowane, lub dokonywanie zmian w połączeniach wiązki (niezgodnych z dołączoną instrukcją) powoduje utratę gwarancji. Zamiana elektronicznych podzespołów w wiązce jest zabroniona. W przypadku jazdy bez przyczepy reduktory nie mogą pozostawać w gnieździe.

Zmiany w instrukcji montażu wiązki dotyczące konstrukcji, wyposażenia kolorów, błędów mogą się zdarzyć. W przypadku gdy przyczepa nie jest wyposażona w światło przeciwmgielne, należy je zamontować.

Za wszystkie zmiany techniczne i elektroniczne dokonane w samochodzie lub w przyczepie po montażu wiązki i mające bezpośredni wpływ na jej działanie nie bierzemy odpowiedzialności.

Między modulem sterującym w wiązce elektrycznej a modulem sterującym samochodem nie ma bezpośredniej komunikacji. W przypadku gdy moduł sterujący samochodem generuje komunikat o błędach, które są bezpośrednie lub pośrednio spowodowane przez moduł wiązki elektrycznej, należy ten moduł odłączyć i przeprowadzić test ponownie.

**WICHTIG!**

Der Einbau dieses Elektrosatzes muß von einer Fachwerkstatt oder einer entsprechend qualifizierten Person durchgeführt werden. Vor Beginn aller Montagearbeiten unbedingt die Einbauanleitung komplett durchlesen. Nach Einbau des Elektrosatzes ist die Einbauanleitung den Serviceunterlagen des Fahrzeuges beizulegen!

Bei unsachgemäßer Anwendung oder Veränderung des Elektrosatzes bzw. der darin befindlichen Bauteile erlischt jeder Anspruch auf Gewährleistung. Beim Fahren ohne Anhänger oder Ladungsträger müssen ggf. verwendete Adapter immer aus der Steckdose entfernt werden. Änderungen bezüglich Konstruktion, Ausstattung, Farbe sowie Irrtum vorbehalten. Alle Angaben und Abbildungen unverbindlich.

Bei Anhängern ohne Nebelschlussleuchte sollte diese nachgerüstet werden.

Für technische bzw. elektronische Änderungen, welche nach erstmaliger Inbetriebnahme des Elektrosatzes vom Fahrzeughersteller durchgeführt werden und beispielsweise zu Fehlfunktionen der Anhängersteckdose oder deren Peripherie führen, übernehmen wir keinerlei Gewährleistung!

Das Anhängermodul ist nicht diagnosefähig! Sollten herstellerseitige Diagnoseprozesse bzw. softwaregestützte Prüfmechanismen Fehlerprotokolle generieren, welche direkt oder indirekt mit Anhängerbetrieb in Zusammenhang stehen, ist das Anhängermodul vom Leitungssatz für die Anhängersteckdose zu trennen und ein nochmaliger Diagnosevorgang zu starten!

**IMPORTANT!**

Installation of the towing electrics kit must be undertaken by a specialist workshop or an appropriately qualified person. Before starting work, you must read the installation instructions through completely. After installing the towing electrics kit, the installation instructions should be kept with the vehicle service documentation.

All claims under the guarantee will lapse in case of improper use or modification of the towing electrics kit or any of its component parts. When driving without a trailer or load carrier, any adapter installed must be removed from the electrical socket. We reserve the right to alter the design, content or colour. We accept no liability for any errors in these instructions. All details and illustrations are non-binding.

In case of missing a rear fog lamp on the trailer, it should be retrofitted.

We accept no responsibility and give no guarantee for technical and electrical modifications made after the initial operation of the towing electrics kit by the vehicle manufacturer and which may lead, for example to malfunction of the trailer socket or its peripheries.

The trailer module is not diagnostics-capable. If the manufacturer's diagnostics processes or software-supported test mechanisms generate error reports directly or indirectly linked with trailer operation, the trailer module must be disconnected from the leads to the trailer socket and a new diagnostic process initiated.

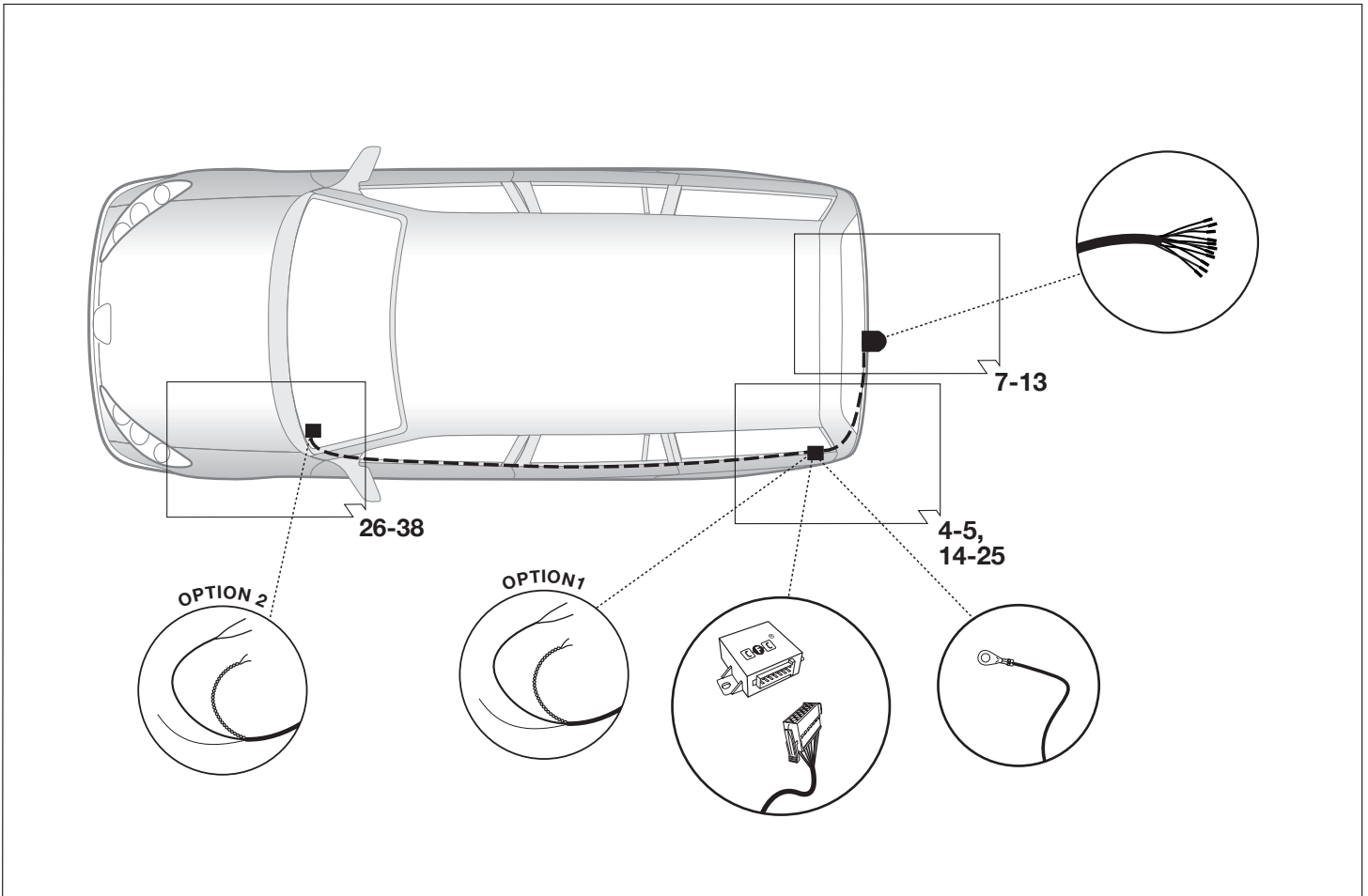
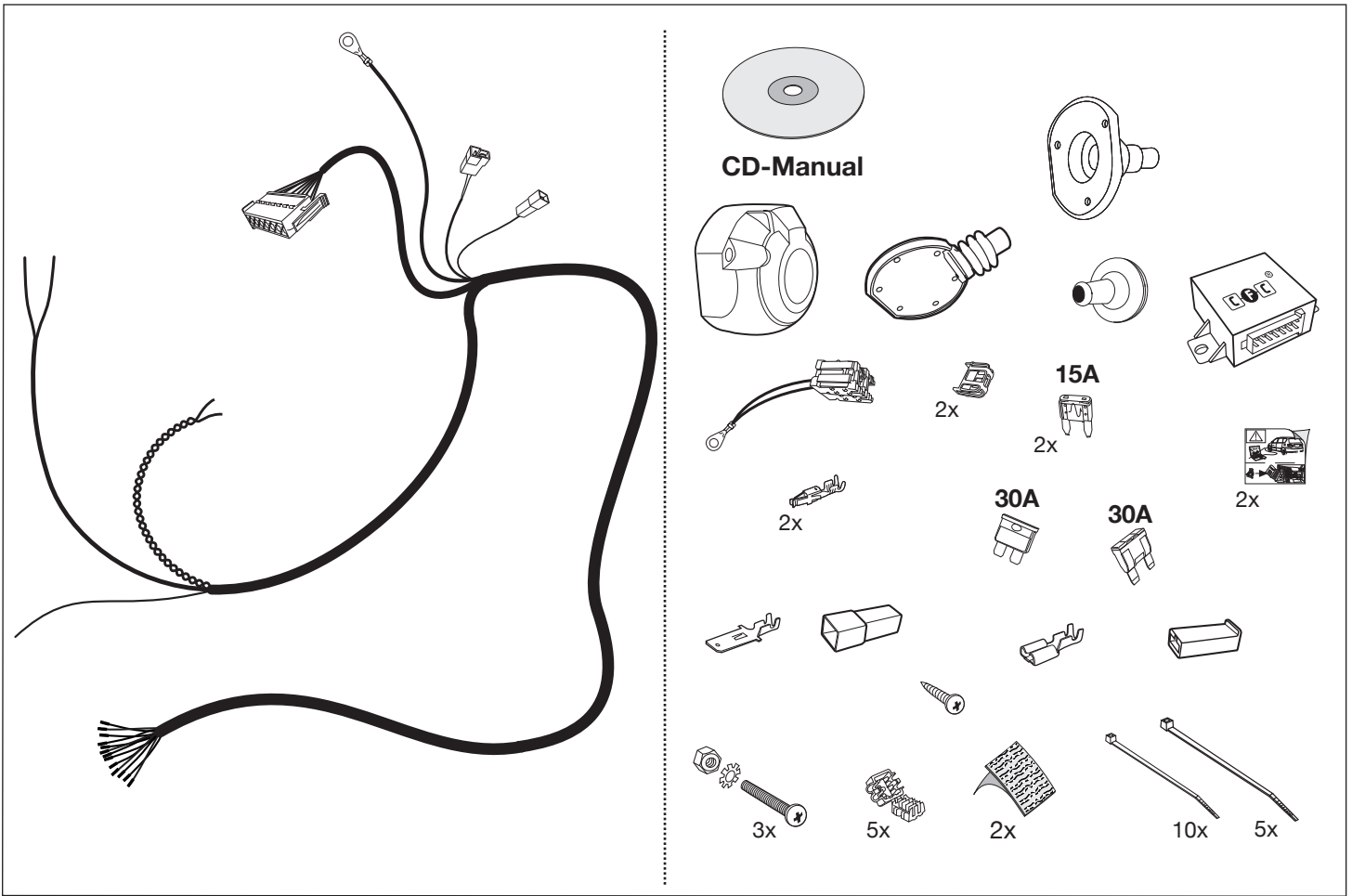

# Nástroje - Narzedzie - Werkzeuge - Tools - Outils

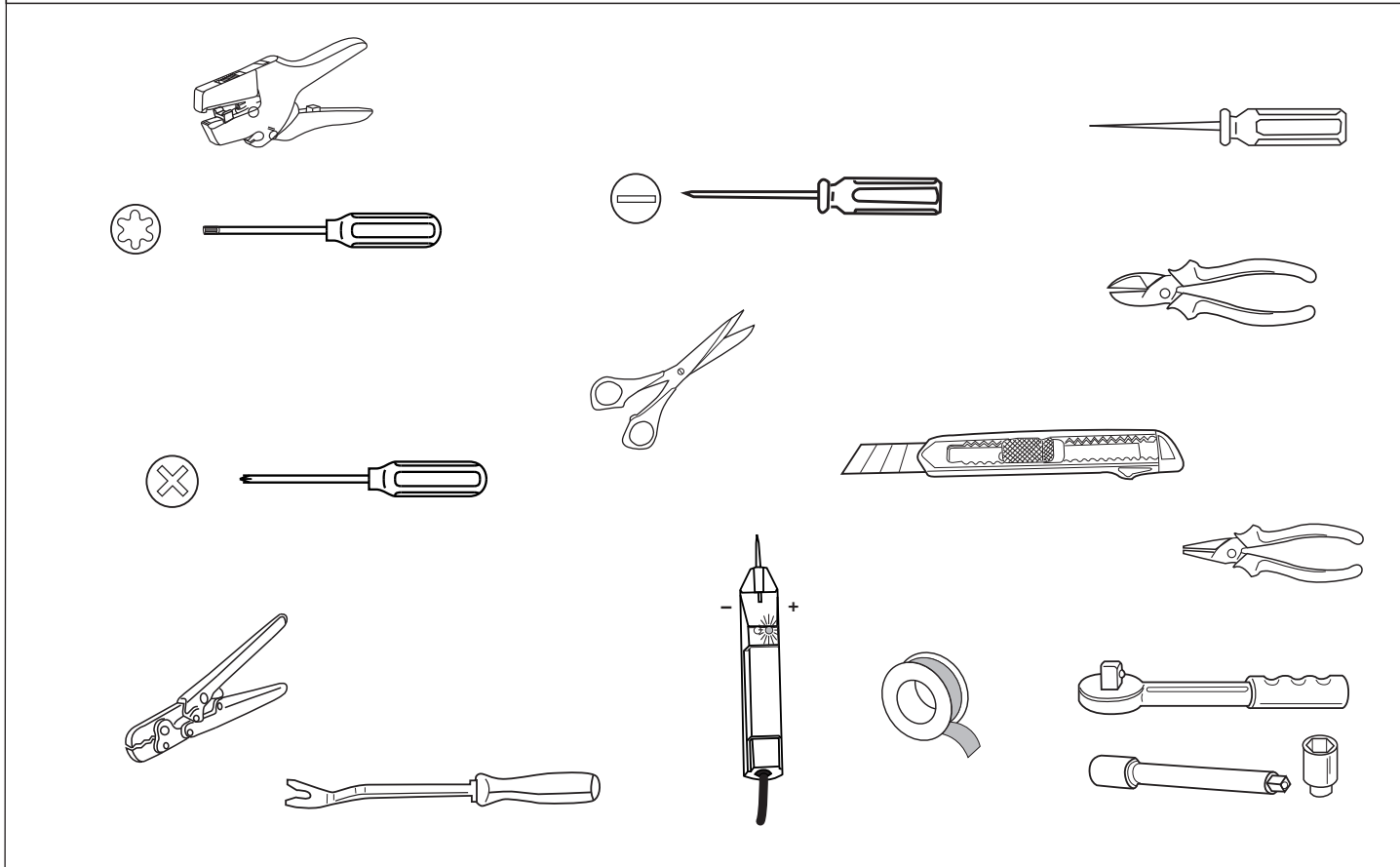

<b>POZOR!</b>	<b>UWAGA!</b>	<b>WICHTIG!</b>	<b>IMPORTANT!</b>						
<b>(SK)</b>	<b>(PL)</b>	<b>(D)</b>	<b>(GB)</b>						
Vykon chladica vozidla musi byt pri doplneni vybavy o tazne zarizenie podla možnosti zvyšeny! Prosim bezpodmienečne dbať na pokyny výrobcu!!	Wydajność układu chłodzenia w zależności od możliwości musi być zwiększona w przypadku zamontowania dodatkowego wyposażenia (hak holowniczy). Proszę koniecznie dbać o zalecenie producenta samochodu!!	Die Kühlerleistung des Fahrzeuges muß bei Nachrüstung einer Anhängerkupplung möglicherweise erhöht werden! Bitte unbedingt Herstellerangaben beachten!!	The vehicle's cooling capacity may have to be increased when retrofitting a trailer coupling! You must observe the manufacturer's instructions!!						

<b>POZOR!</b>	<b>UWAGA!</b>	<b>WICHTIG!</b>	<b>IMPORTANT!</b>
<b>(SK)</b>	<b>(PL)</b>	<b>(D)</b>	<b>(GB)</b>
Aby sa zabránilo zbytočným chybám v palubnej sieti, <b>musi</b> byť odpojená akumulátorová svorka na negatívny (minus) pól ešte <b>pred začatím</b> montáže!  Obzvlášť pri prácach a pripojeniach na CAN-datovej zbernici môže dôjsť pri neodpojení akumulátorovej svorky k poškodeniu modulu príviesu ako aj k poškodeniu palubného modulu vozidla!  Prosíme dodržiavať pokyny výrobcu pri odpojení a pripojení akumulátora!	Aby zapobiec zbytecznym bledom w elektronice samochodu, <b>należy przed rozpoczęciem</b> montażu wiązki odłączyć klemę (-) MINUS od akumulatora!  W przypadku nie odłączenia klemy, szczególnie przy montażu modułu CFC (CAN Bus) może nastąpić uszkodzenie tego modułu w wiązce jak również uszkodzenie modułu sterującego w samochodzie!  Dlatego prosimy przestrzegać instrukcji producenta przy odłączaniu i załączaniu klemy akumulatora.	Um Störungen und Schäden am Bordnetz zu vermeiden, <b>muß</b> die Massepolklemme <b>unbedingt vor Beginn aller Arbeiten</b> von der Fahrzeugbatterie getrennt werden!  Insbesondere bei Arbeiten und Anschlüssen am CAN-Datenbus kann bei nicht abgeklemmter Batterie sowohl das Anhängermodul als auch das fahrzeugseitige Bordnetzsteuergerät beschädigt werden!  Bitte Herstellervorschriften beim Ab- und Anklemmen der Fahrzeugbatterie beachten!	In order to avoid mal-functions and damage to the vehicle's electrical system the earth terminal <b>must</b> be disconnected from the vehicle's battery <b>before starting work!</b>  Both the trailer module and the vehicle's control unit for the electrical system can be damaged during work on the CAN data bus connections if the battery is not disconnected!  Please pay attention to the manufacturer's instructions when disconnecting and reconnecting the vehicle's battery!



Peugeot 3008

a

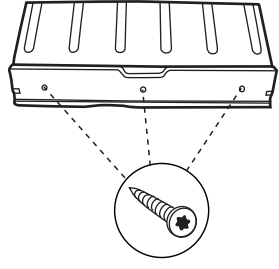
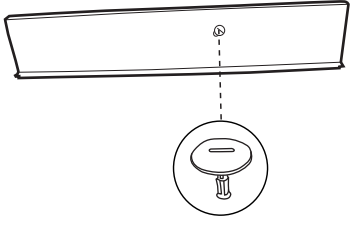
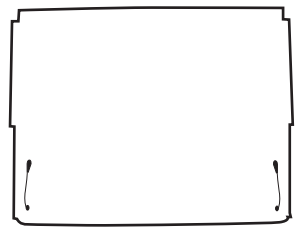
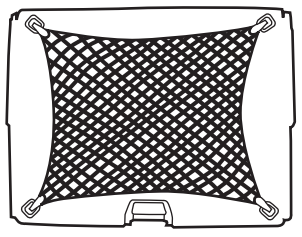
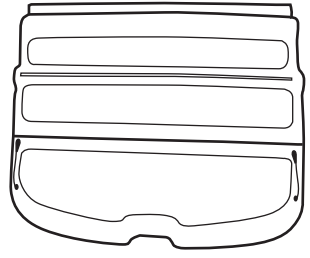
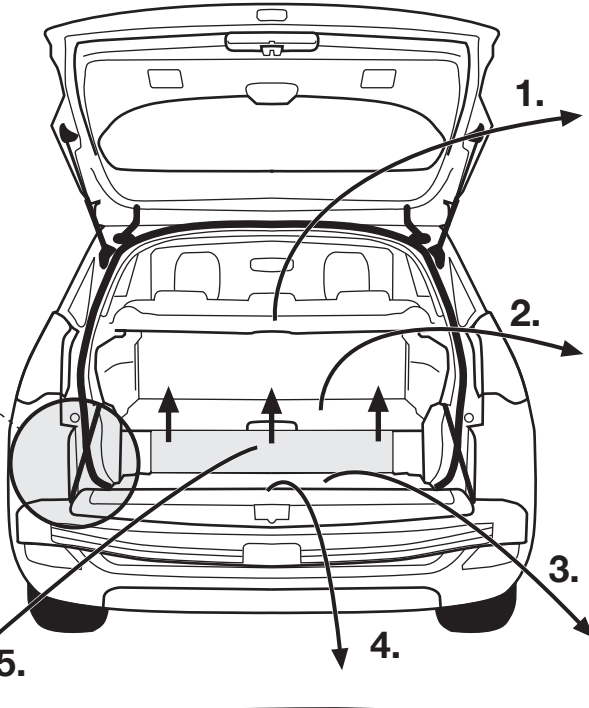
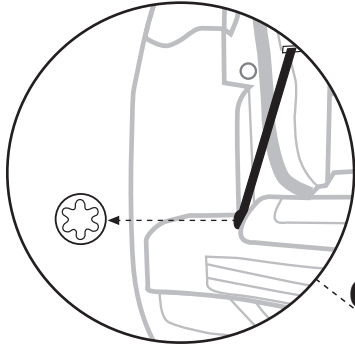

b

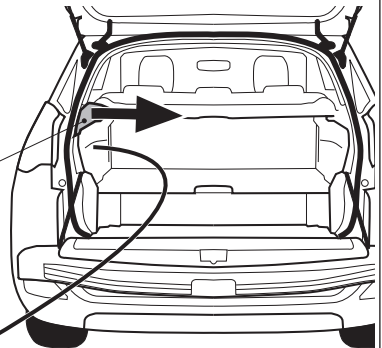
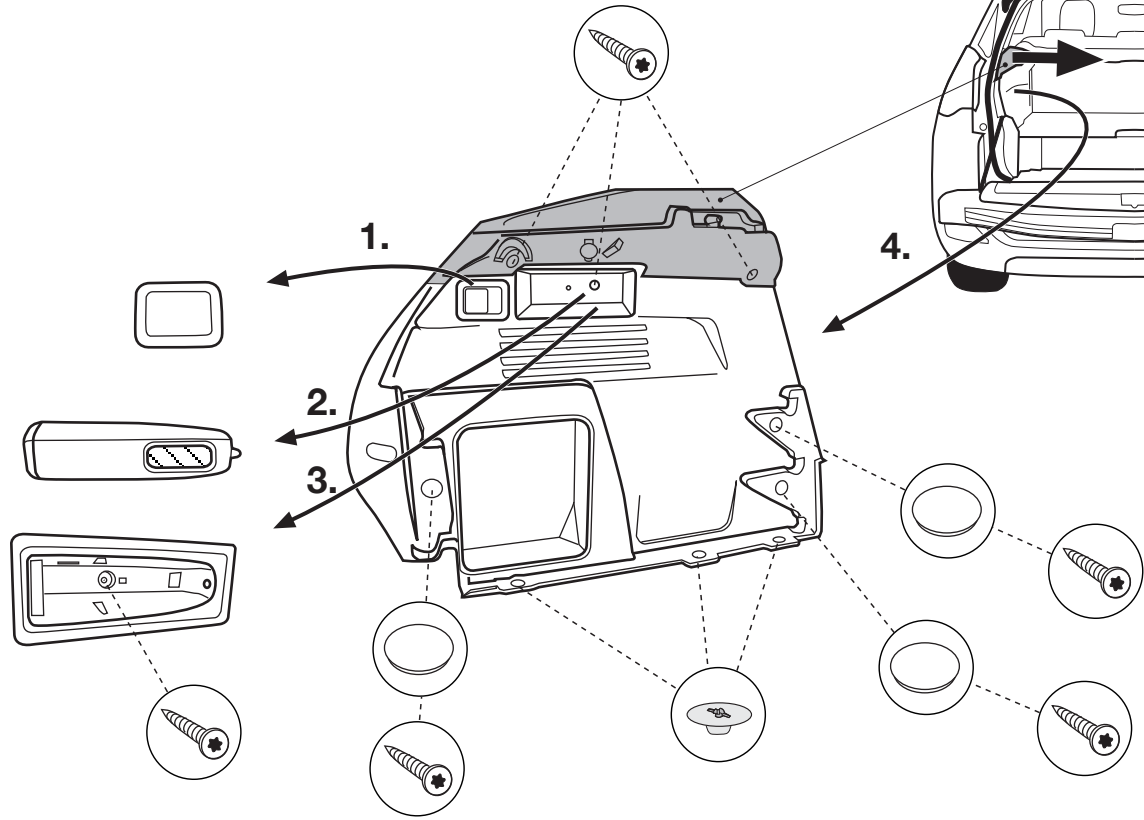



Peugeot 5008

a

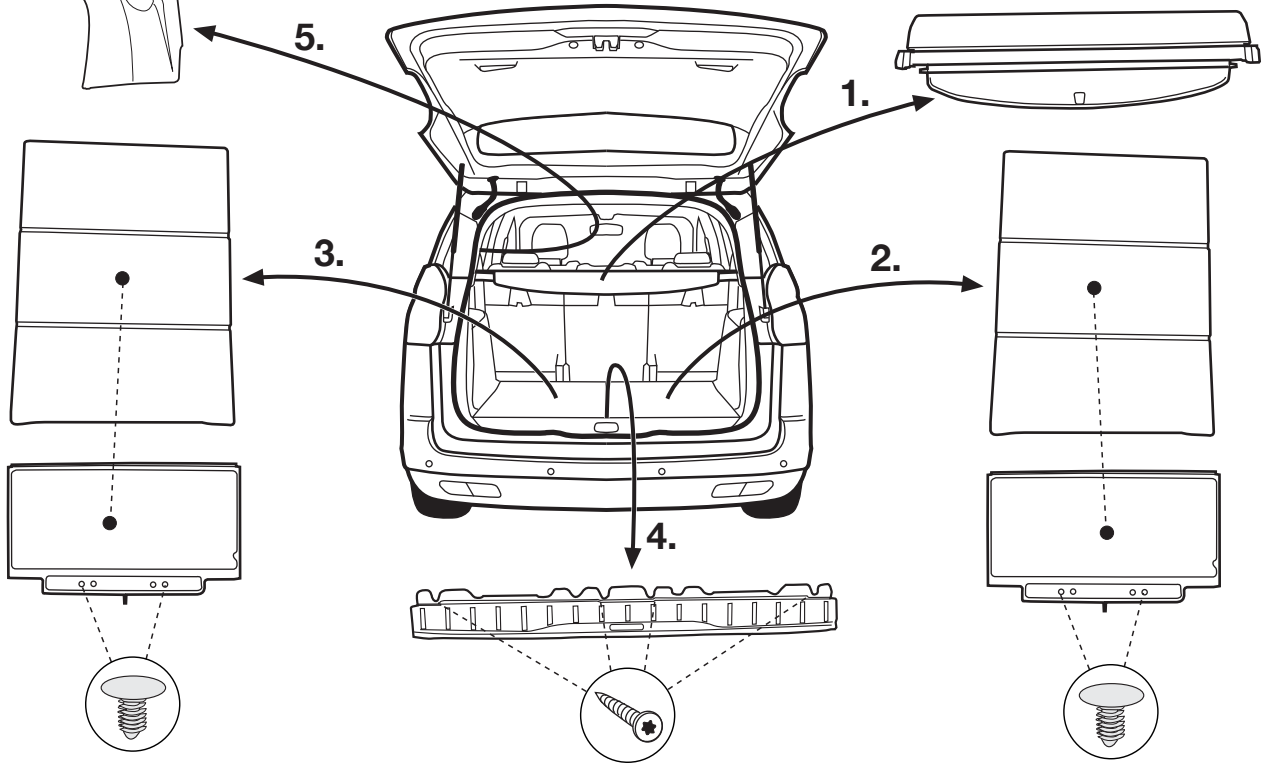

b

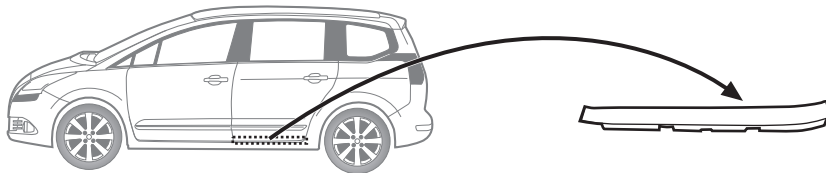

c

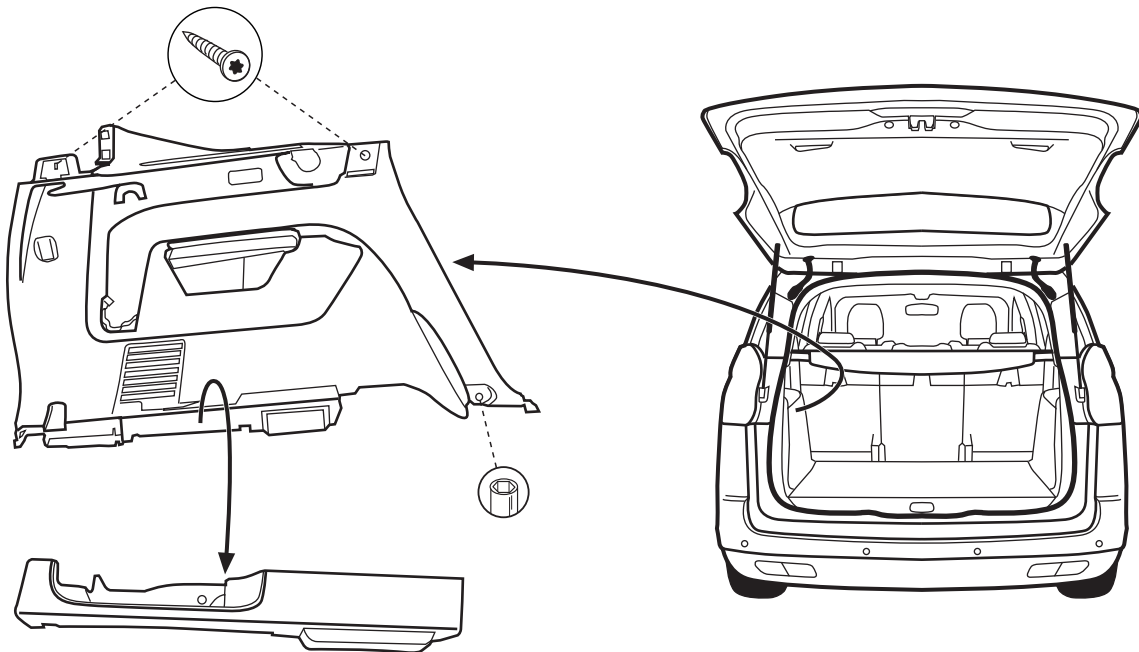

3



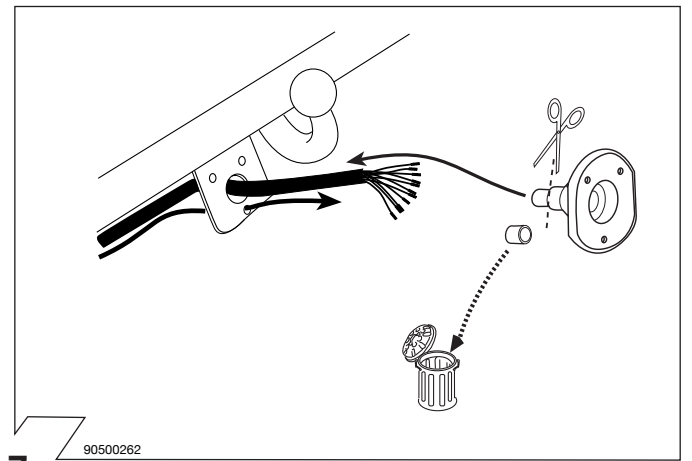
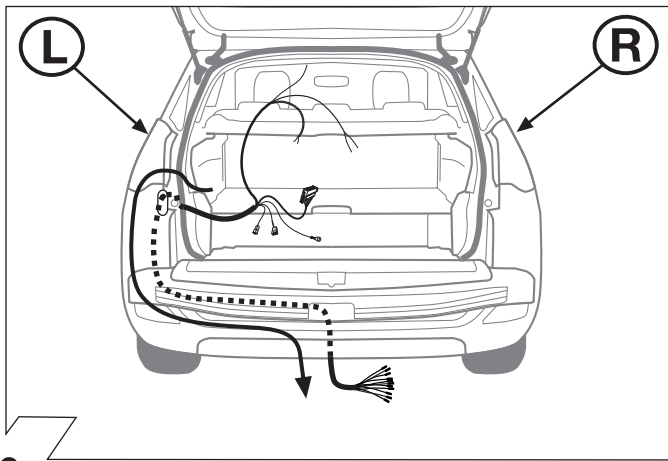
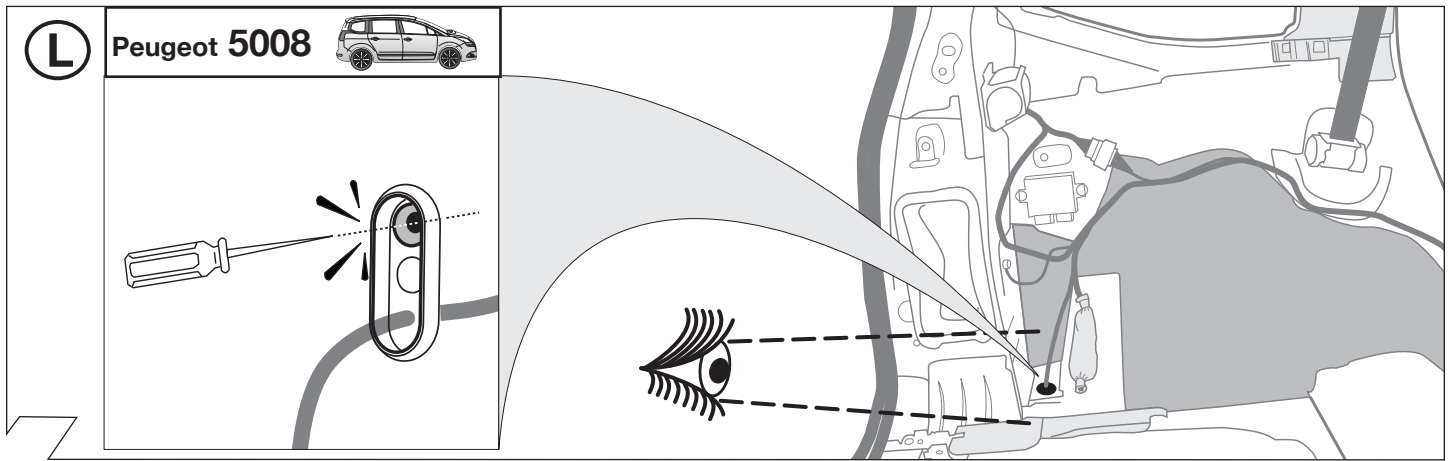
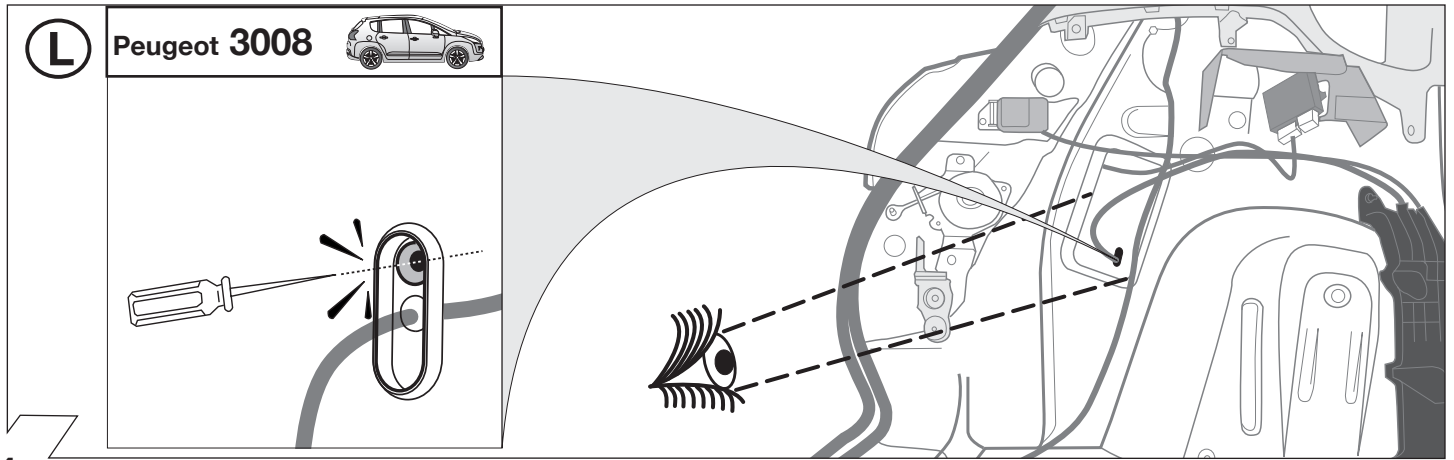

90500580

	GB	D	E	F	I	P	NL	DK	N	S	FIN	CZ	H	PL
BK	Black	Schwarz	Negro	Noir	Nero	Preto	Zwart	Sort	Svart	Svart	Musta	Černá	Fekete	Czarny
RD	Red	Rot	Rojó	Rouge	Rosso	Vermelho	Rood	Röd	Röd	Röd	Punainen	Červená	Piros	Czerwony
GN	Green	Grün	Verde	Vert	Verde	Verde	Groen	Gron	Grönt	Grön	Vihreä	Zelená	Zöld	Zielony
OR	Orange	Orange	Naranja	Orange	Arancione	Laranja	Oranje	Orange	Orange	Orange	Oranssi	Oranzová	Narancs	Pomarańczowy
VT	Violet	Violett	Violeta	Violet	Viola	Violeta	Violet	Violet	Fiolett	Violett	Violetti	Fialová	Ibolya	Fioletowy
PK	Pink	Pink	Pink	Rose	Rosa	Cor-de-Rosa	Paars	Pink	Pink	Rosa	Pinkki	Růžová	Rózsaszín	Różowy
BL	Blue	Blau	Azul	Bleu	Blu	Azul	Blauw	Blå	Blått	Blå	Sininen	Modrá	Kék	Niebieski
YL	Yellow	Gelb	Amarillo	Jaune	Giallo	Amarelo	Geel	Gul	Gult	Gul	Keltainen	Zlutá	Sárga	Żółty
WT	White	Weiss	Blanco	Blanc	Bianco	Branco	Wit	Hvid	Hvitt	Vit	Valkoinen	Bílá	Fehér	Biały
BR	Brown	Braun	Marrón	Brun	Marrone	Marrom	Bruin	Brun	Brunt	Brun	Ruskea	Hnědá	Barna	Brazowy
GY	Grey	Grau	Gris	Gris	Grigio	Cinzeno	Grijs	Grå	Grått	Grå	Harmaa	Sedá	Szürke	Szary

8

ISO 11446		Podłączenie gniazda / Maksymalne obciążenie na wyjściu Obloženie zásuvky/Maximálny výkon na výstupe Belegung der Steckdose / Maximale Ausgangsleistung Socket Configuration/Maximum power output		
	1/L	BK/WT	21W	
	2	WT	42W	
	3/31	BR		
	4/R	BK/GN	21W	
	5/58-R	GY/RD	52W	
	6/54	BK/RD	63W	
	7/58-L	GY/BK	52W	
	8	BL/RD	42W	
	9	RD	240W	
	10	YL	180W	
	11	YL/BR		
	12			
	13	RD/BR		

9

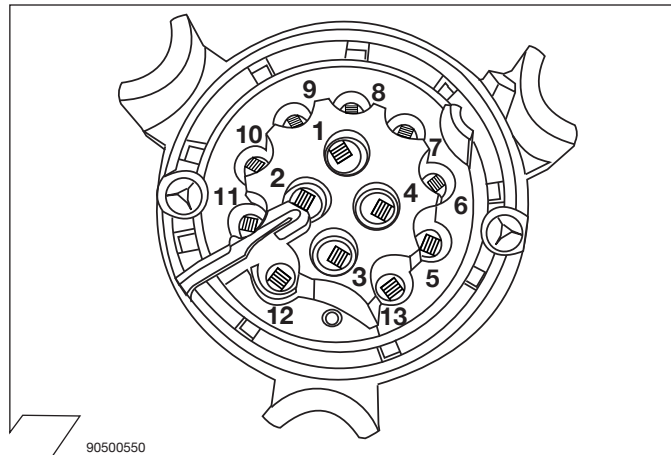

10

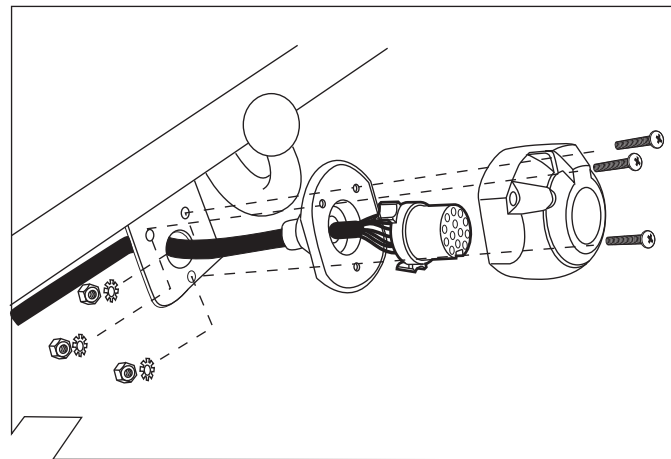

11

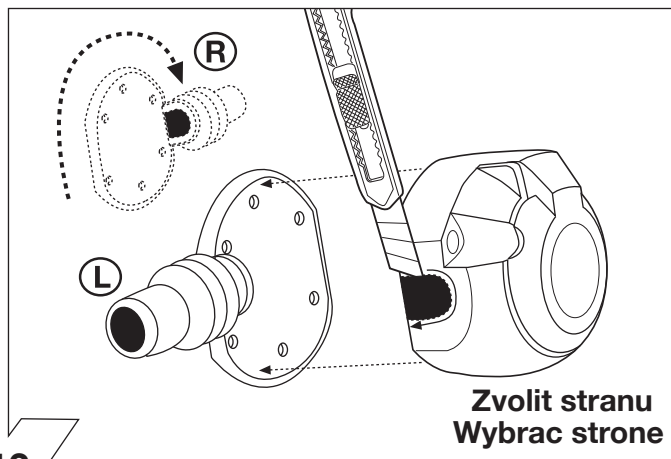

12

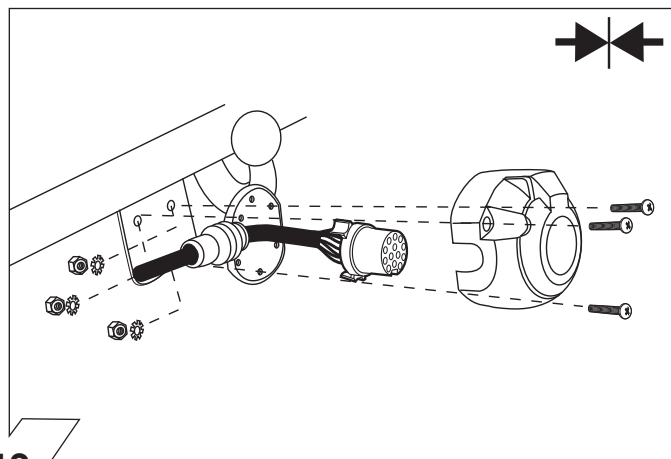

13

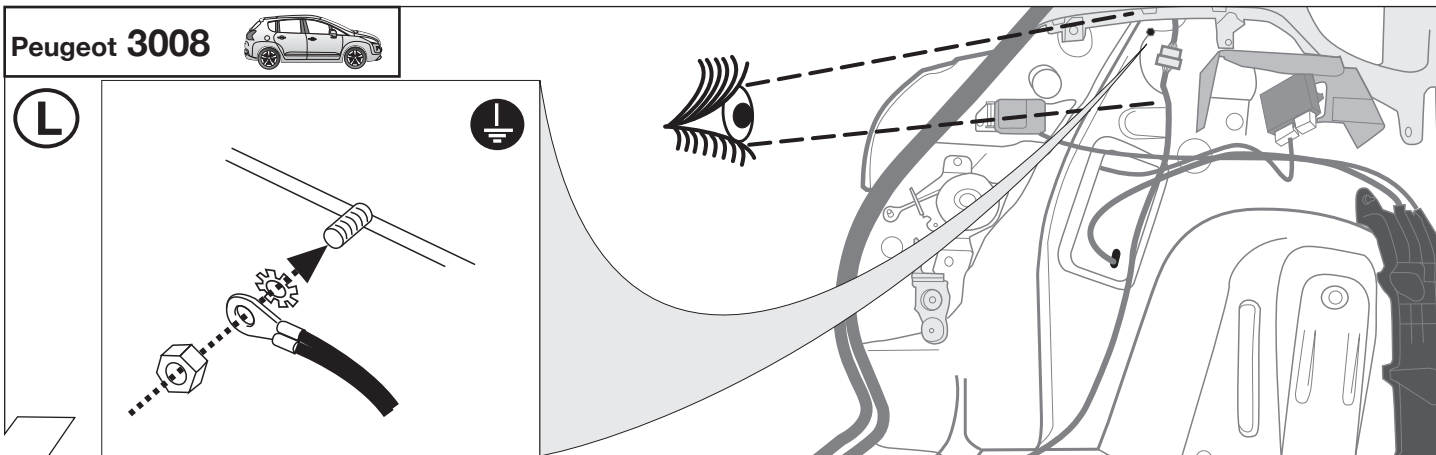

14



Peugeot 5008 

L

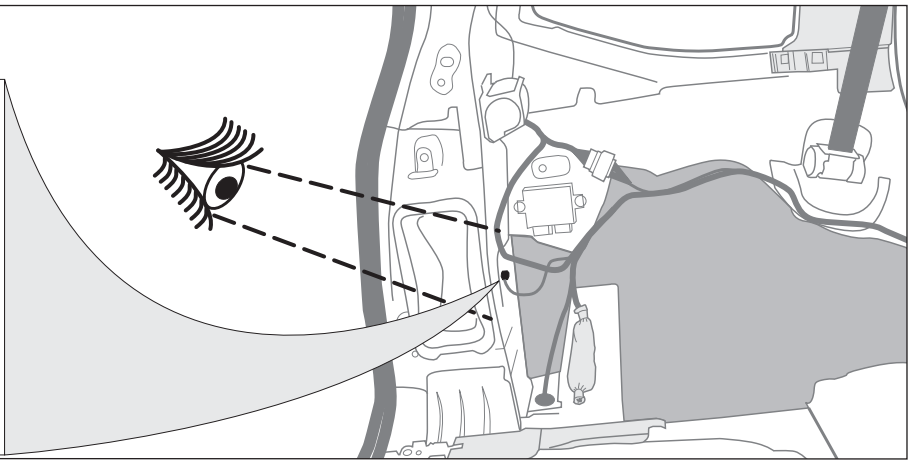
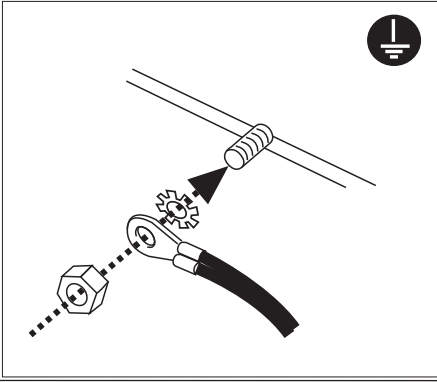

15

Peugeot 3008 

L

  
**Dôležitě!**  
 Dbať na pokyny z obrázku 1!  
**Uwaga!**  
 Zwrocić szczególną uwagę pokazane czynności na obrazku 1

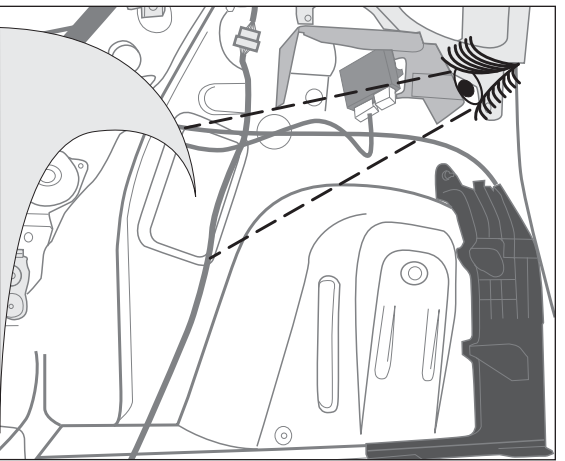
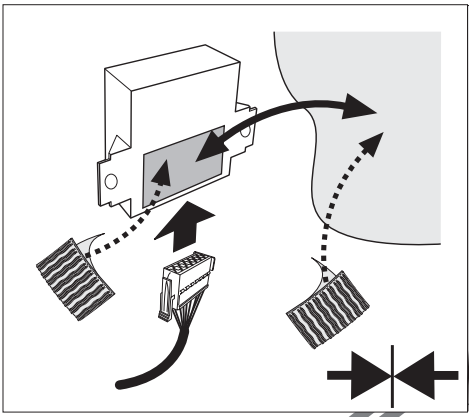

16

Peugeot 5008 

L

  
**Dôležitě!**  
 Dbať na pokyny z obrázku 1!  
**Uwaga!**  
 Zwrocić szczególną uwagę pokazane czynności na obrazku 1

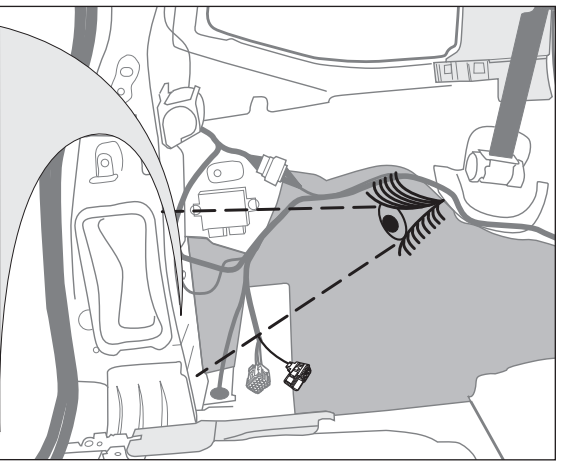
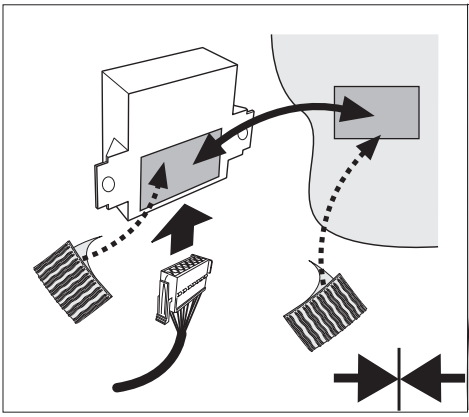

17

**OPCJA 1**  
**OPCJA 1**

Peugeot 3008 

L

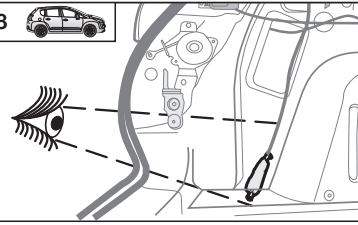

Peugeot 5008 

L

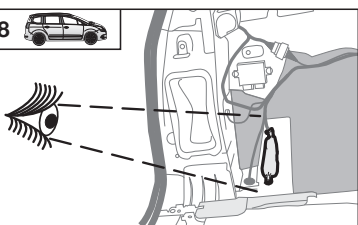

**Vozidla s pripravou pre prives**

**Dla samochodow z złączem instalacji elektrycznej haka**

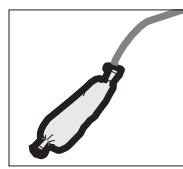

**20 - 29**  
**39 - 49**

18

**OPCJA 2  
OPCIA 2**

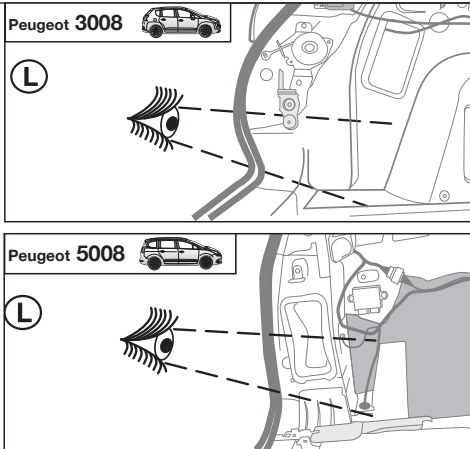

Vozidla BEZ prípravy pre prives

Samochody BEZ zlacza  
instalacji elektrycznej haka

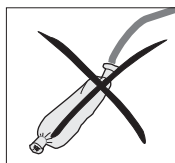

**30 - 49**

19

**Peugeot 3008**



**OPCJA/OPCIA 1**

**L**

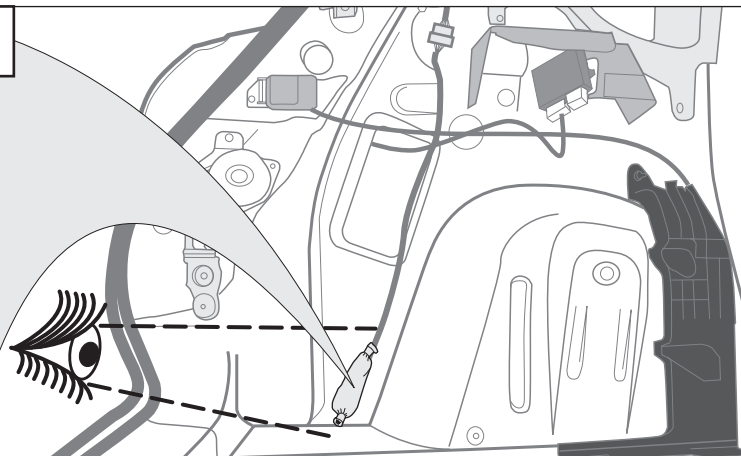
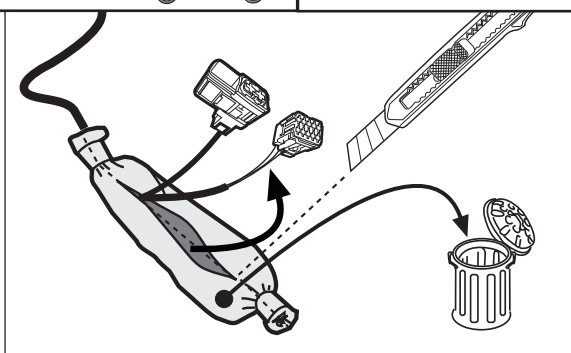

20

**Peugeot 5008**



**OPCJA/OPCIA 1**

**L**

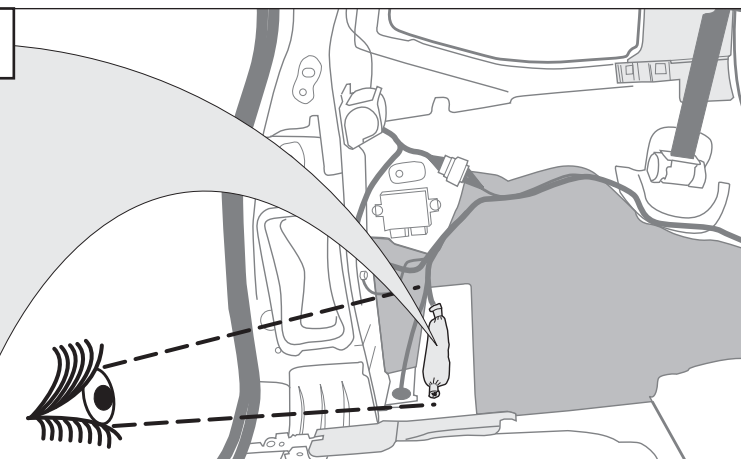
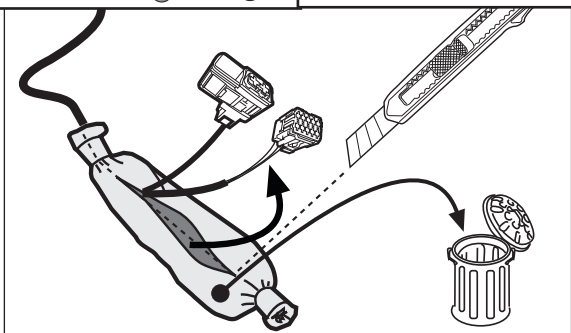

21

**OPCJA/OPCIA 1**

**1.**

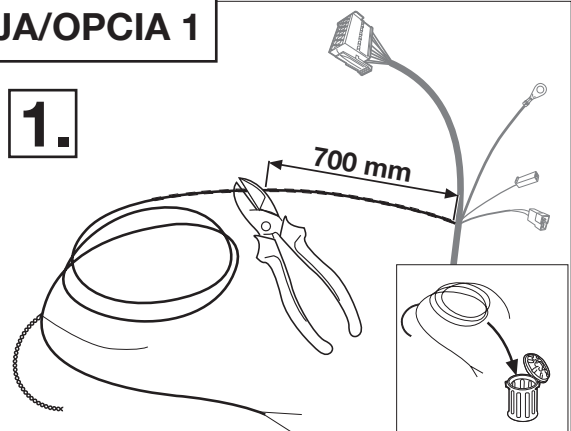

**2.**

BK/YL  
RD/BL  
RD/YL  
BK YL

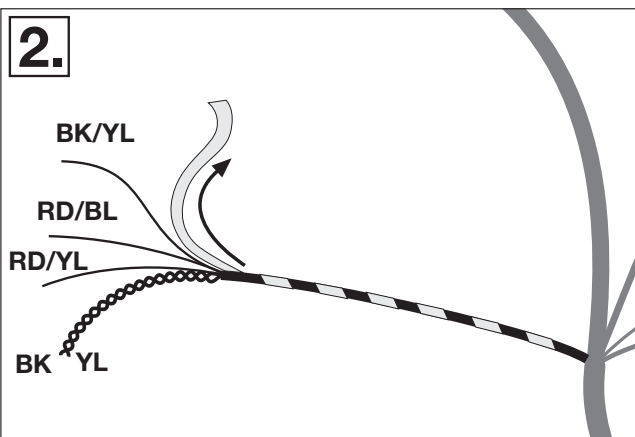

22

**OPCJA/OPCIA 1**

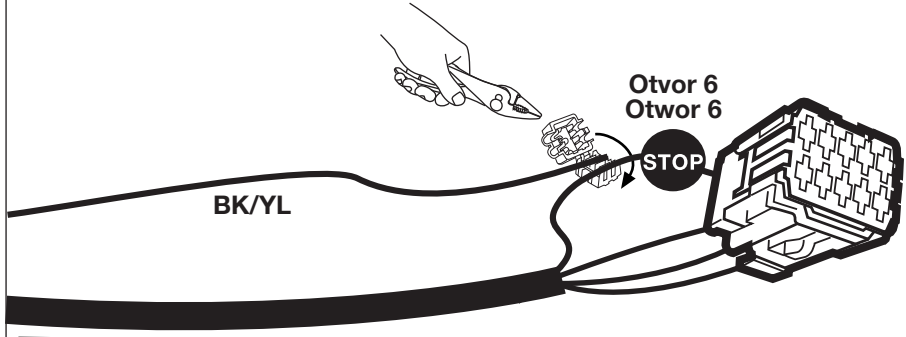

Puzdro zastrzki 10-polové (BK)  
Obudowa wtyczki 10-pinowej (BK)

23

**OPCJA/OPCIA 1**

**Dôležit!**  
Dbat na pokyny z obrázku 1!

**Uwaga!**  
Zwróc szczególną uwagę pokazane czynności na obrázku 1

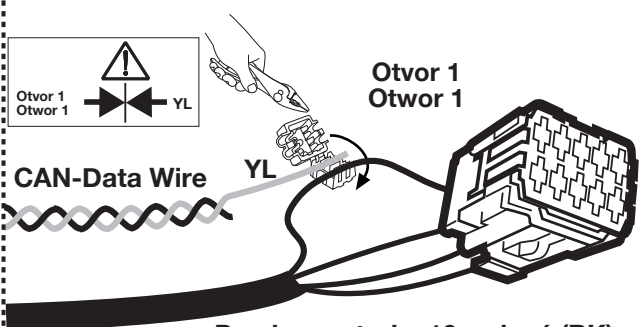
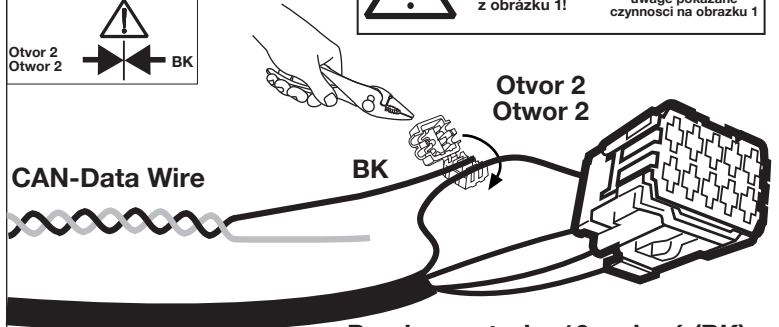

Puzdro zastrzki 10-polové (BK)  
Obudowa wtyczki 10-pinowej (BK)

Puzdro zastrzki 10-polové (BK)  
Obudowa wtyczki 10-pinowej (BK)

24

**OPCJA/OPCIA 1**

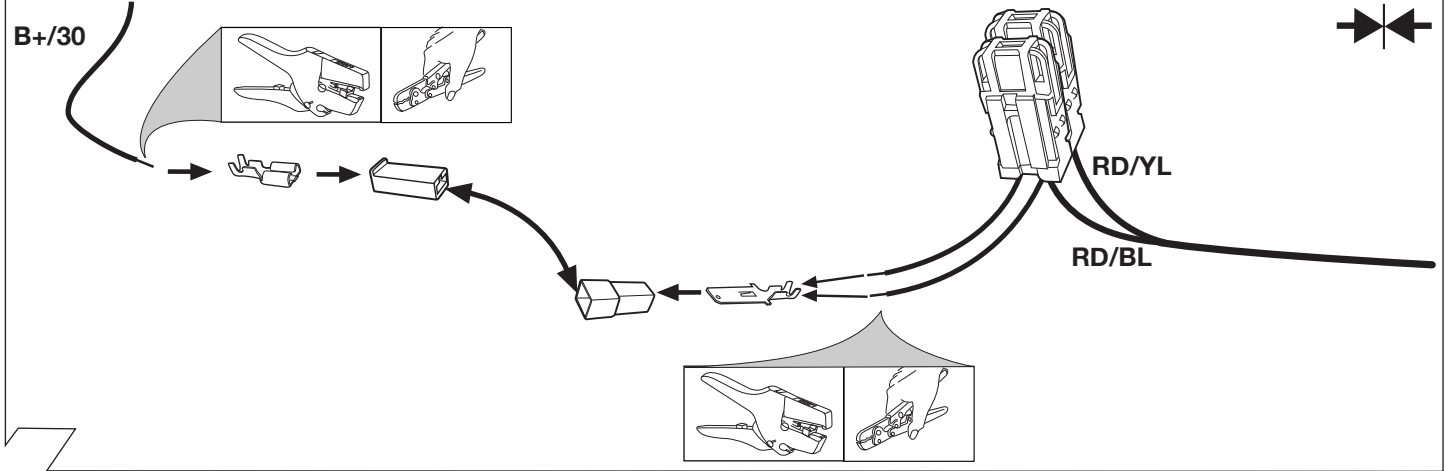
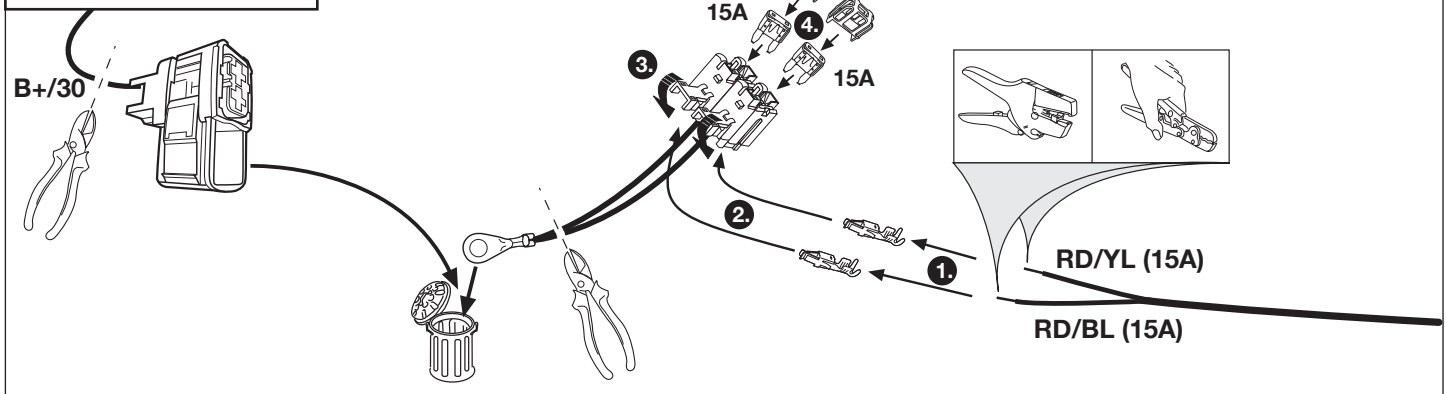

25

OPCJA/OPCIA 1

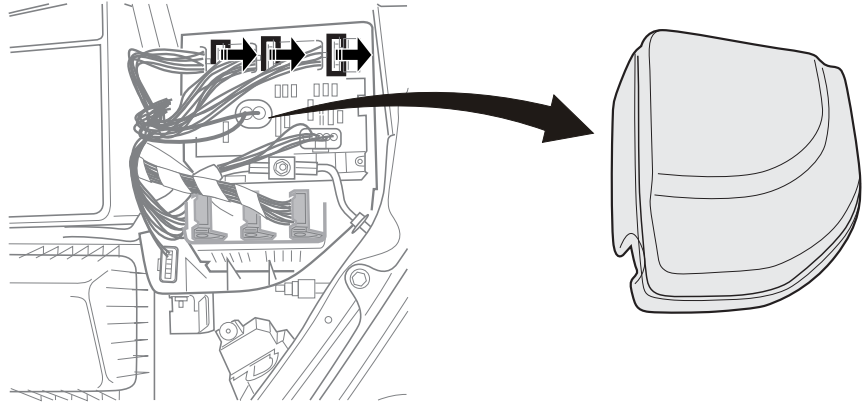
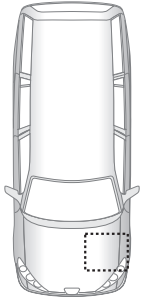

26

OPCJA/OPCIA 1

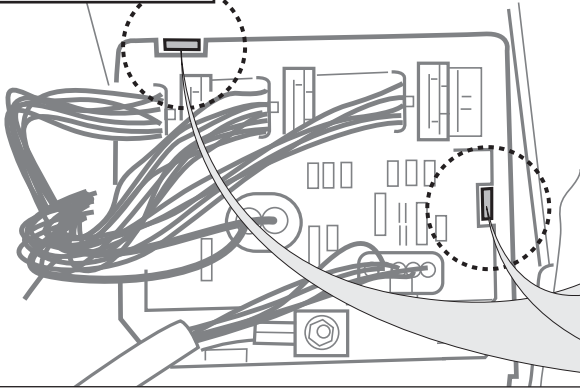

27

OPCJA/OPCIA 1

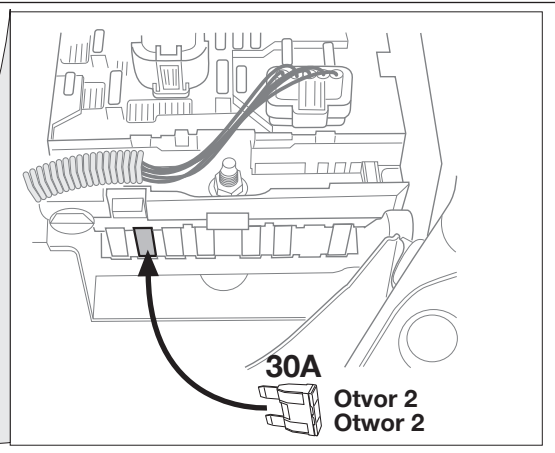
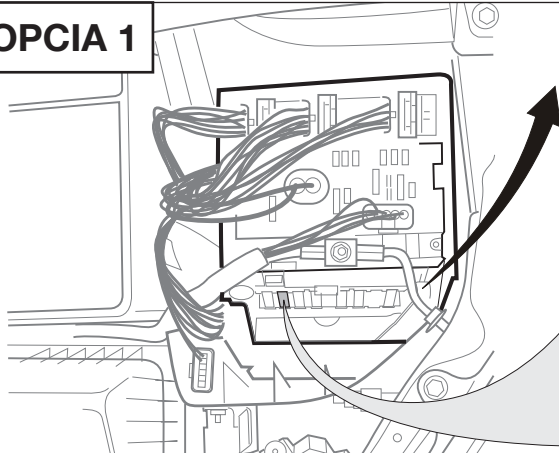

28

OPCJA/OPCIA 1

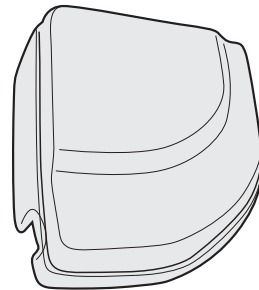
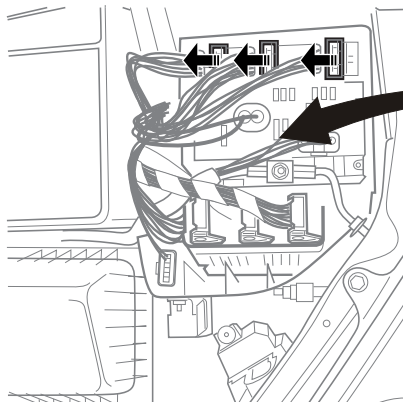

29

90030118

**OPCJA/OPCIA 2**

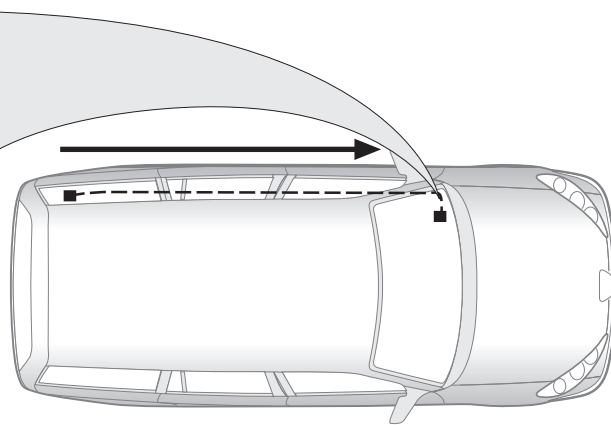
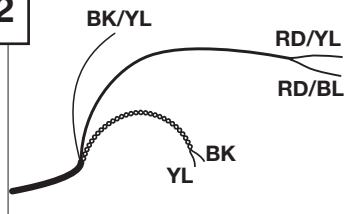

30

90030169

**OPCJA/OPCIA 2**

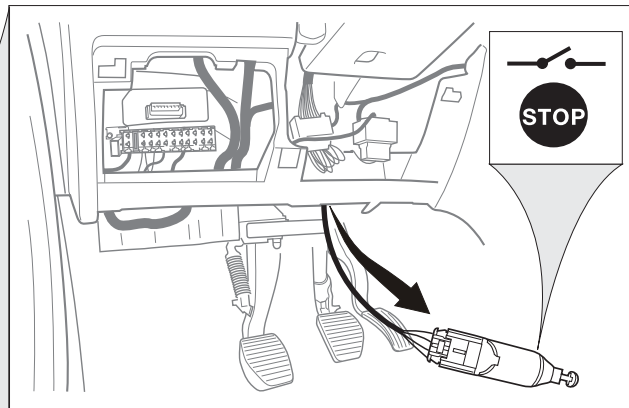
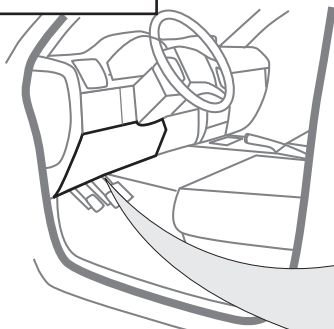

31

90160114

**OPCJA/OPCIA 2**

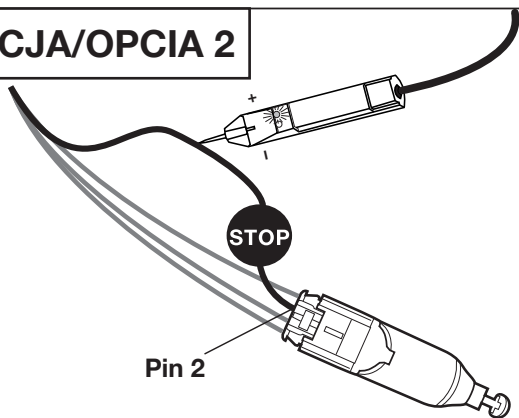

32

90160115

**OPCJA/OPCIA 2**

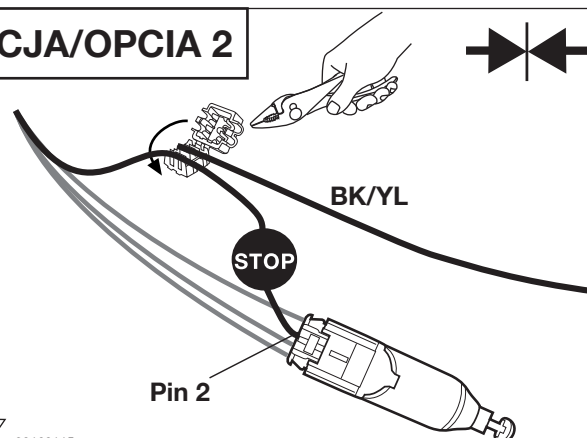

33

90160115

**OPCJA/OPCIA 2**

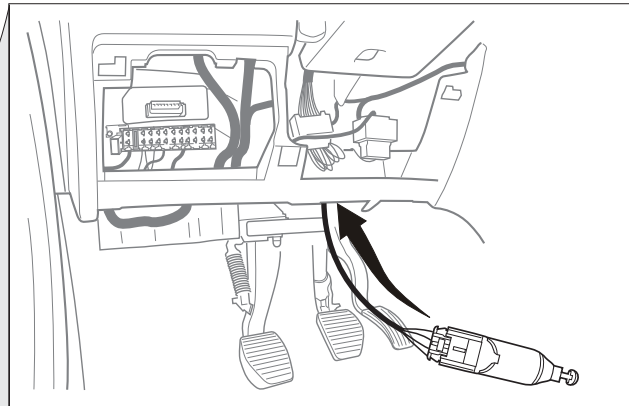
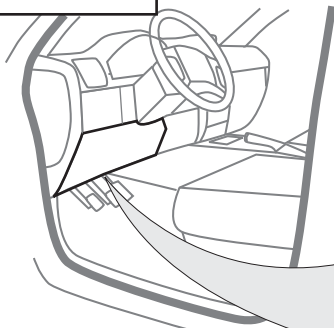

34

90160114



**OPCJA/OPCIA 2**

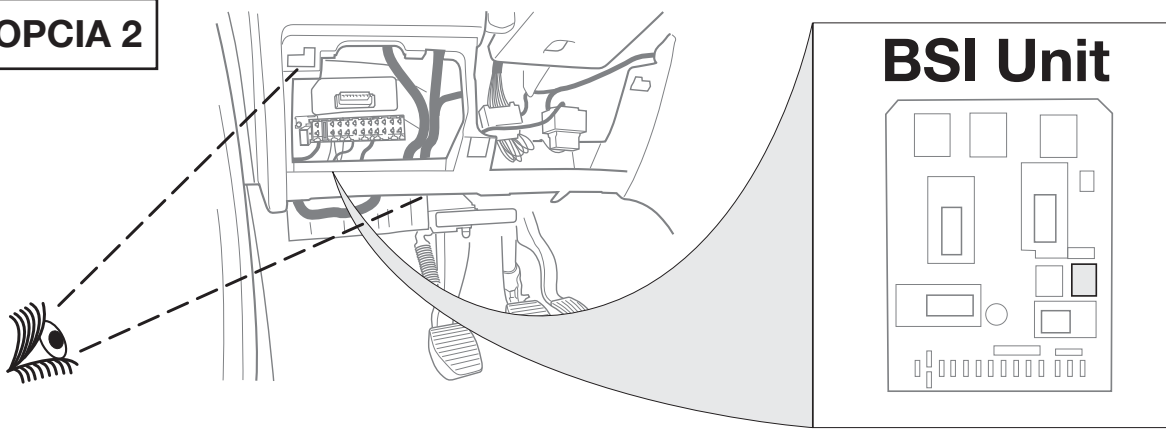

35



**Dôležit!**  
Dbať na pokyny  
z obrázku 1!

**Uwaga!**  
Zwrócić szczególną  
uwagę pokazane  
czynności na obrazku 1

**OPCJA 2  
OPCIA 2**

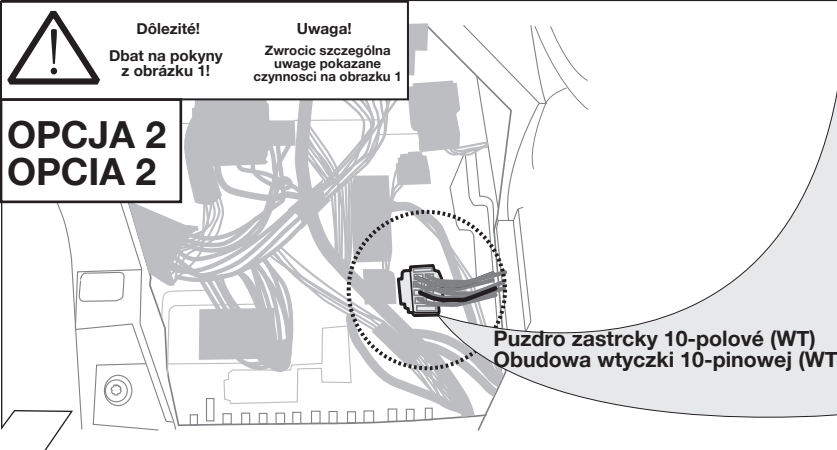

Puzdro zastrčky 10-polové (WT)  
Obudova wtyczki 10-pinowej (WT)

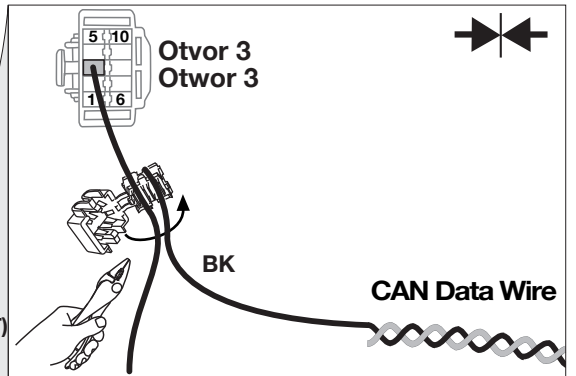

36



**Dôležit!**  
Dbať na pokyny  
z obrázku 1!

**Uwaga!**  
Zwrócić szczególną  
uwagę pokazane  
czynności na obrazku 1

**OPCJA 2  
OPCIA 2**

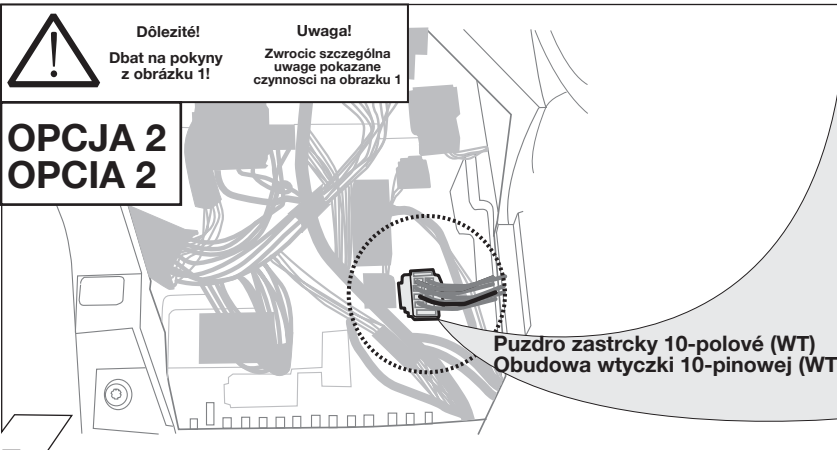

Puzdro zastrčky 10-polové (WT)  
Obudova wtyczki 10-pinowej (WT)

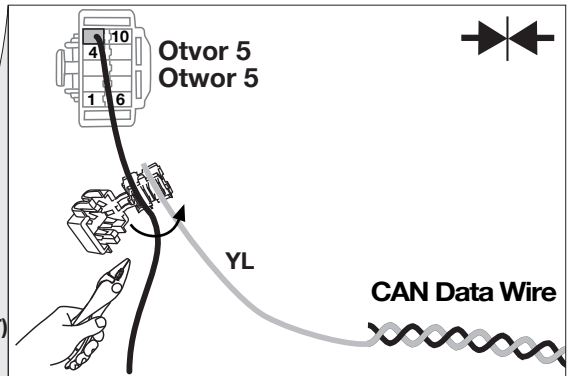

37

**OPCJA/OPCIA 2**

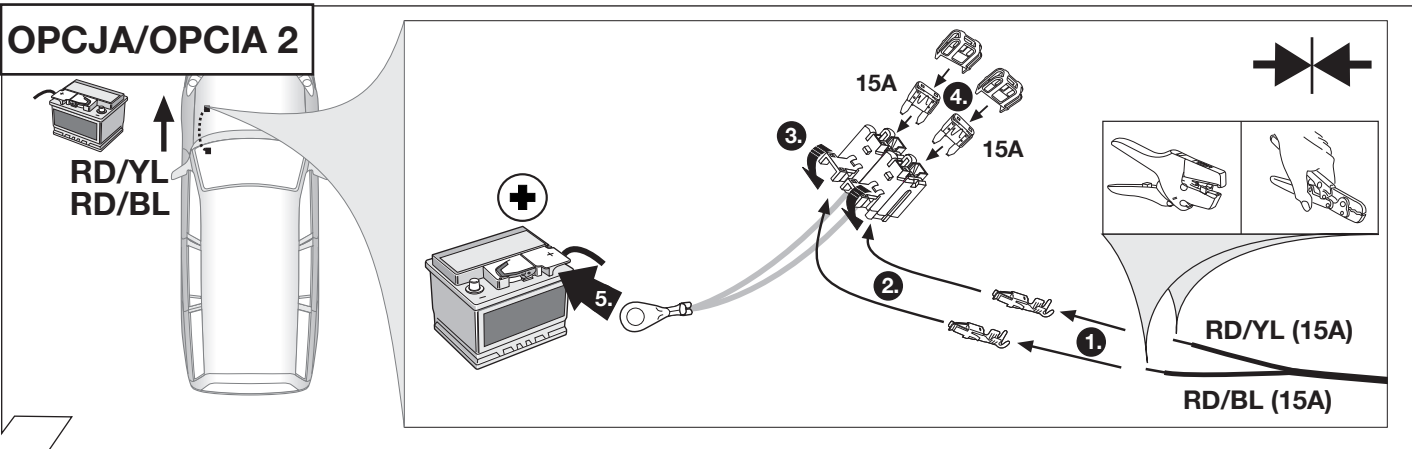

38



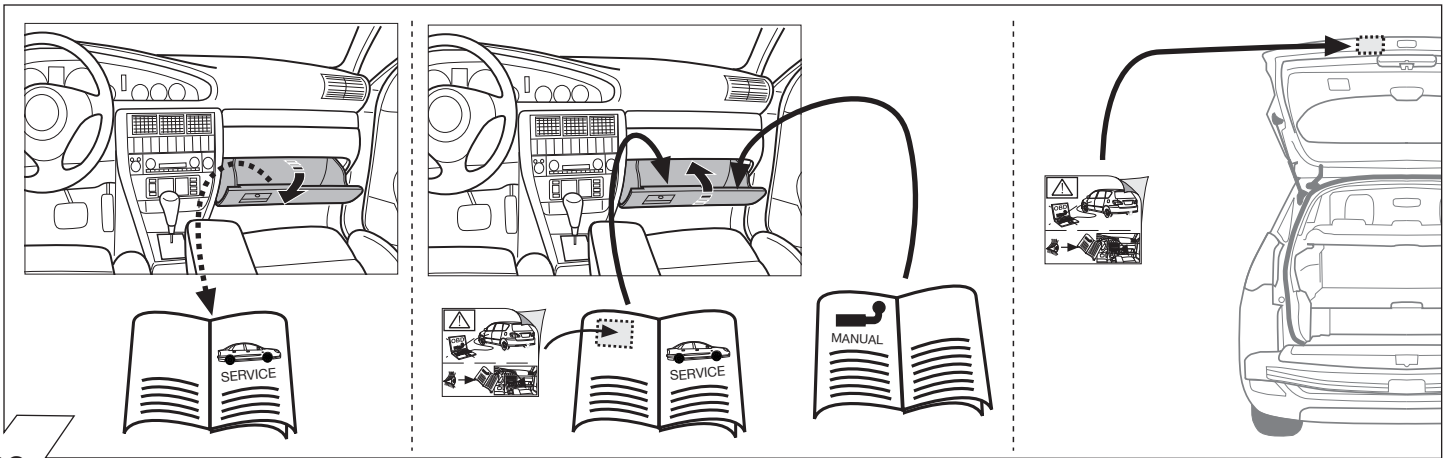

39

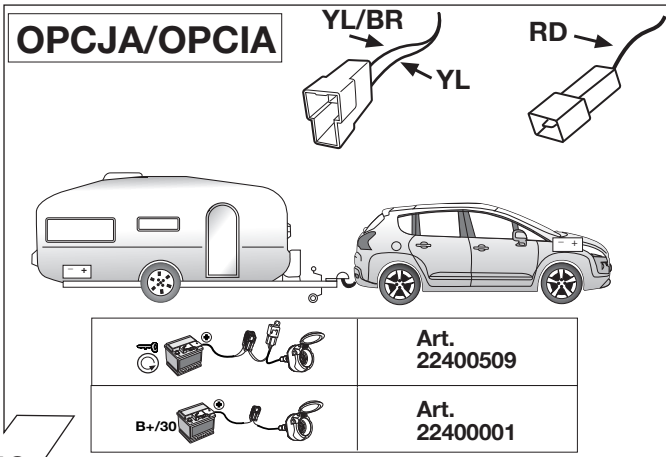

40

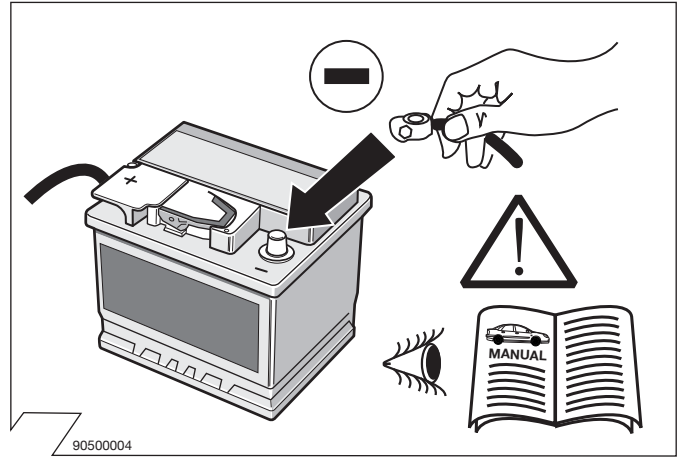

41



42

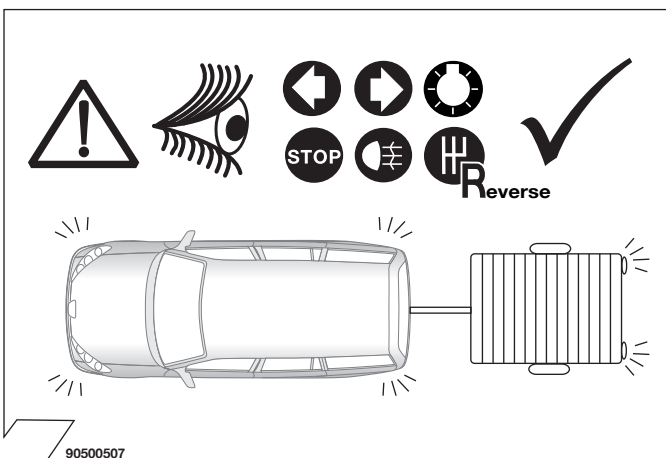
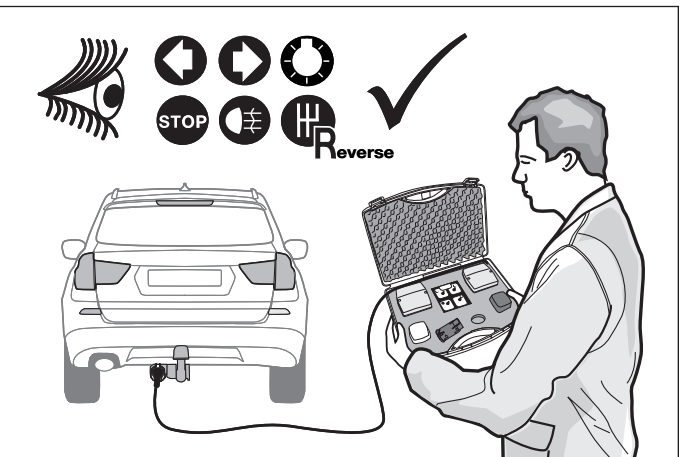

43

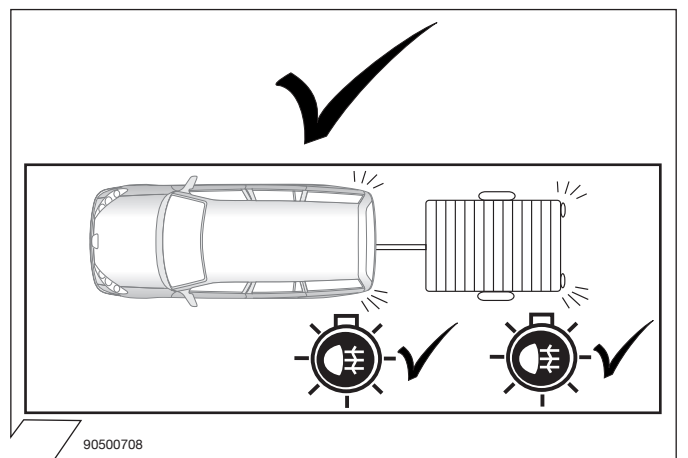

44

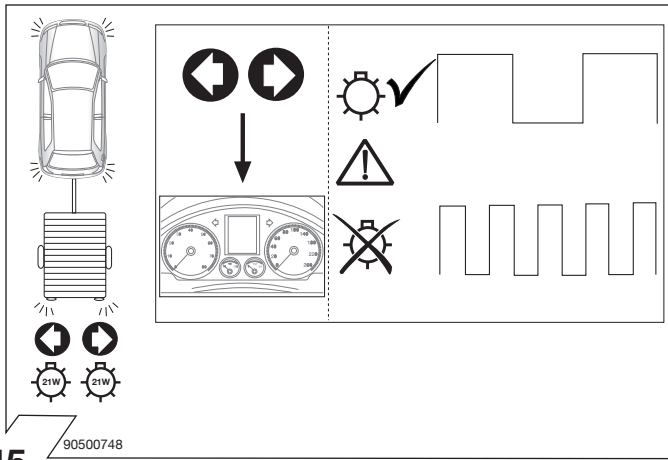

45

90500748

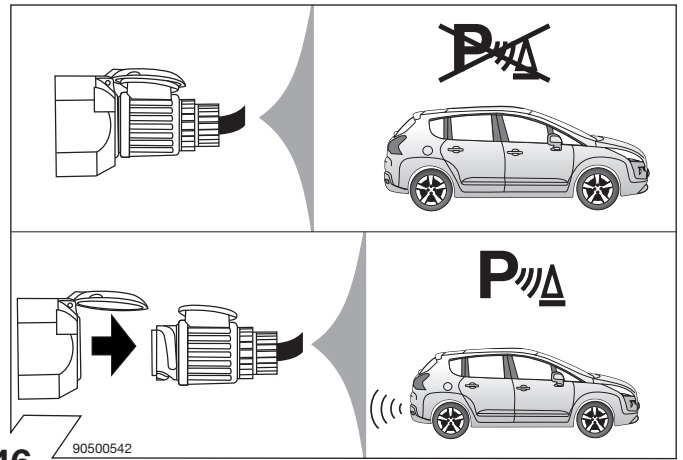

46

90500542

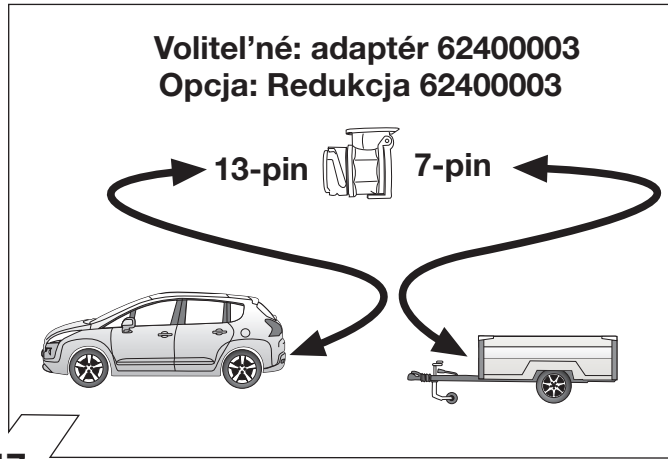

47

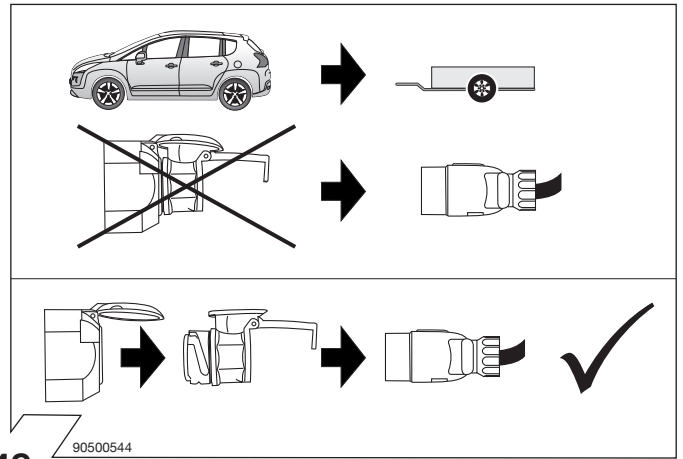

48

90500544



Programowanie  
 Programovanie  
 Programmierung  
 Programming

Strona 17  
 Strana 17  
 Seite 17  
 page 17

## Aktivácia funkcie tazného zariadenia

## Aktywacja funkcji haka holowniczego

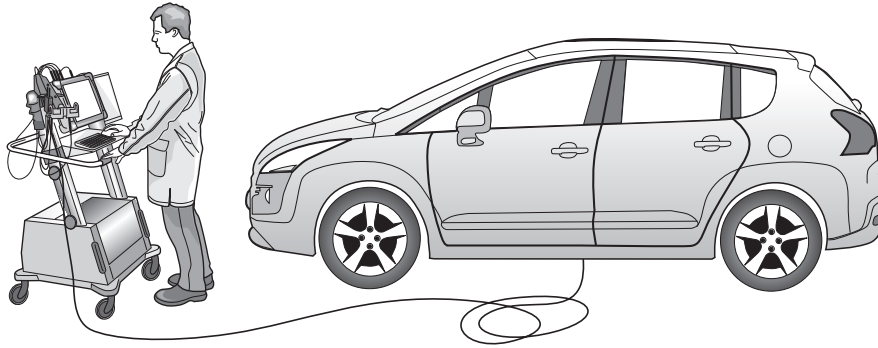

### Aktywacja

- kontroli kierunkowskazów przyczepy
- deaktywacja asystenta parkowania

musi być wykonana za pomocą PEUGEOT PPS-testera i PEUGEOT Planet Office Software następująco:

- wybór samochodu
- wybór użycia Peugeot Planet 2000
- dodatkowe wyposażenie
- hak holowniczy
- montaż haka holowniczego



### Aktivacia

- kontroly smerových svetiel privesu
- deaktywacja asystenta parkowania

musi być uskutocnena za pomoci PEUGEOT PPS-testera a PEUGEOT Planet Office Software nasledovne:

- vyber vozidla
- vyber pouzitia Peugeot Planet 2000
- mimoriadna vybava
- vlecný hak
- montáž tazného zariadenia



### Die Aktivierung von

- Anhänger-Blinküberwachung
- Einparkhilfe-Deaktivierung

musi mit Hilfe des PEUGEOT PPS-Testers und der PEUGEOT Planet Office Software wie folgt durchgeführt werden:

- Wahl des Fahrzeuges
- Wahl der Anwendung Peugeot Planet 2000
- Sonderausstattung
- Schlepphaken
- Montage Anhängerkupplung































### The activation of

- trailer indicator monitoring
- PDC deactivation

must be carried out using the PEUGEOT PPS Tester and PEUGEOT Planet Office Software as follows:

- Select the vehicle
- Select the application Peugeot Planet 2000
- Optional extras
- Tow hook
- Installation towbar

Vysvetlivky k symbolom	Objasnenia symboli	ERKLÄRUNG SYMBOLE	SYMBOL EXPLANATION
(SK)	(PL)	(D)	(GB)
 ľavé (58-L) resp. pravé (58-R) koncové svetlá	Lewe(58-L)lub pravé (58-R) koncové sviatlo	linke (58-L) bzw. rechte (58-R) Schlussleuchte	left (58-L) respectively right (58-R) tail light
 Brzdové svetlá (54)/ tretie brzdové svetlá (54)	Swiatlo stop (54)/ trzecie swiatlo stop (54)	Bremsleuchte (54) / 3. Bremsleuchte (54)	stop light (54) / high mounted, third stop light (54)
 Smerové svetlo ľavé	Kierunkowskaz lewy	Fahrtrichtungsanzeiger links	turn signal indicator left
 Smerové svetlo pravé	Kierunkowskaz prawy	Fahrtrichtungsanzeiger rechts	turn signal indicator right
 Hmlové svetlo(á)	przeciwniegielne swiatlo	Nebelschlussleuchte(n)	rear fog light(s)
 Spättné svetlo (á)	swiatlo wsteczne	Rückfahrleuchte(n)	reversing light(s)
 Trvalé plus/zásuvka 13 polová, kontakt 9	staly plus/ gniazdo 13 biegunowe, kontakt 9	Dauerstrom / Steckdose 13P Kammer 9	Permanent power supply / 13pin socket, chamber 9
 Nabijací kábel/ zásuvka 13-polová, kontakt 10	przewód ładujący/ gniazdo 13 biegunowe, kontakt 10	Ladeleitung / Steckdose 13P Kammer 10	charging wire for trailer fridge / 13pin socket, chamber 10
 Prives/rozpoznanie privesu	przyczepa/rozpoznanie przyczepy	Anhänger / Anhängererkennung	trailer / trailer recognition
 Trvalé plus/stály prívod prúdu	staly plus/stale napiecie	Dauerstrom / permanente Stromversorgung	Permanent current power supply
 Kostra (31)	masa 31	Masse (31)	Ground or Earth (31)
 Pólová svorka batérie - minus	klema baterii - minus	Batteriepolklemme Anschluss Minus	ground connection battery terminal lug
 Pólová svorka batérie - plus	klema baterii - plus	Batteriepolklemme Anschluss Plus	positive connection battery terminal lug
 Poistka/Vykon poistky 20 Ampère	Bezpiecznik/ amperaz 20A	Sicherung / Sicherungsstärke 20 Ampère	fuse / fuse capacity 20 Ampère
 Zapalovac/doplnková zásuvka	Zapalniczka/ gniazdo uzupełniajace	Zigarettenanzünder / Zubehör-Steckdose	cigarette lighter / accessory socket
 Reprodukotor/húkačka	klakson	Lautsprecher / Warnsummer	loudspeaker / buzzer
 Parkovací senzor	czujnik(sensor) parkowania	Einparkhilfe	park distance control
 Prepínac/zdroj funkcie	Przelacznik	Schalter / Funktionsursprung	switch / source of function
 Spojit	polczyc	verbinden	Connect together
 Rozpojtit	rozlaczyc	trennen	disconnect
 Sledovat/vid. dalsie informácie	sledzic/ patrz nastepne informacje	beachten / siehe weitere Informationen	Look at / see further information
 Sledovat vybranú oblasť	sledzic/wybrana czesc	beachte auserwählten Bereich	look carefully at selected area
 Nachádzajúci sa/osadený/v poriadku	znajdujacy sie/w porzadku	vorhanden / belegt / i.O.	Present / Occupied / OK
 Nenachádzajúci sa/neosadený/ nie v poriadku	nie znajdujacy sie/ nie w porzadku	nicht vorhanden / nicht belegt / nicht i.O.	Not present / Not occupied / not OK
 Nalavo	na lewo	links	left
 Napravo	na prawo	rechts	right
 Zvuková signalizácia	dzwiekowa sygnalizacja	Akustische Signalisierung	acoustic indication
 Pozor/dôležitá informácia	Uwaga/ wazna informacja	Achtung / wichtiger Hinweis	attention / important advice

905007 80