

# LOGAN MCV 2

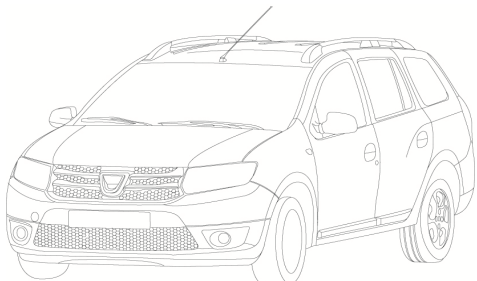

**Kg** 1750 kg



**Kg** 1150 kg

**D** 6,81 kN

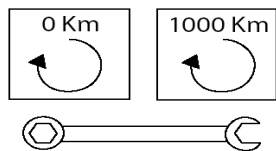
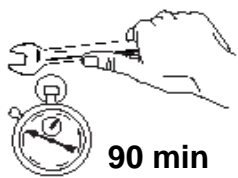
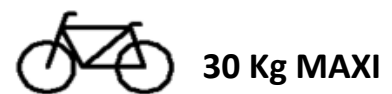
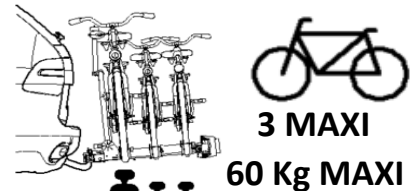

SI 217  
e24\*55R\*01\*0349  
SI 218  
e24\*55R\*01\*0350

**316341**

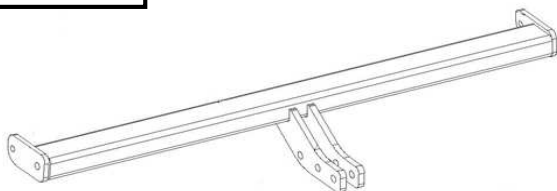

**Kg** 15 kg



**316342**

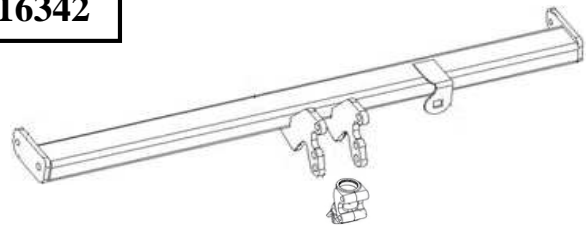

**Kg** 18 kg

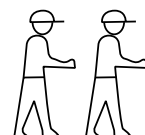
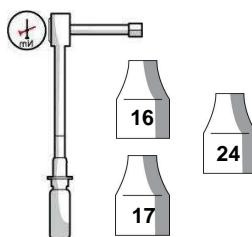
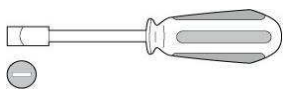
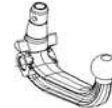



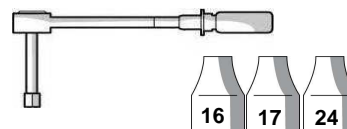



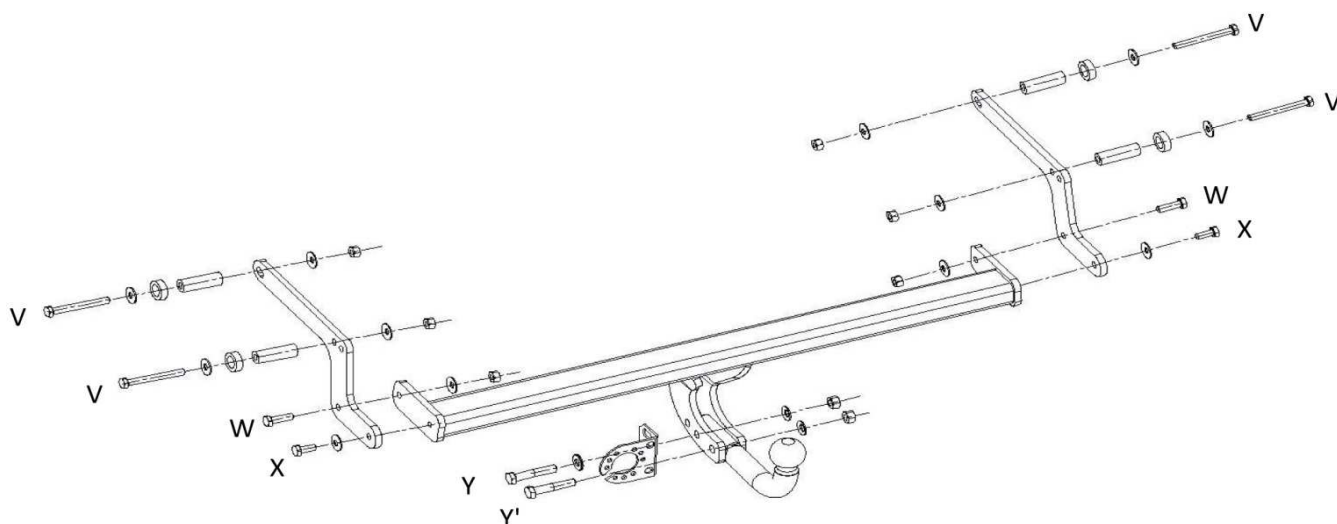









**16 - 17**











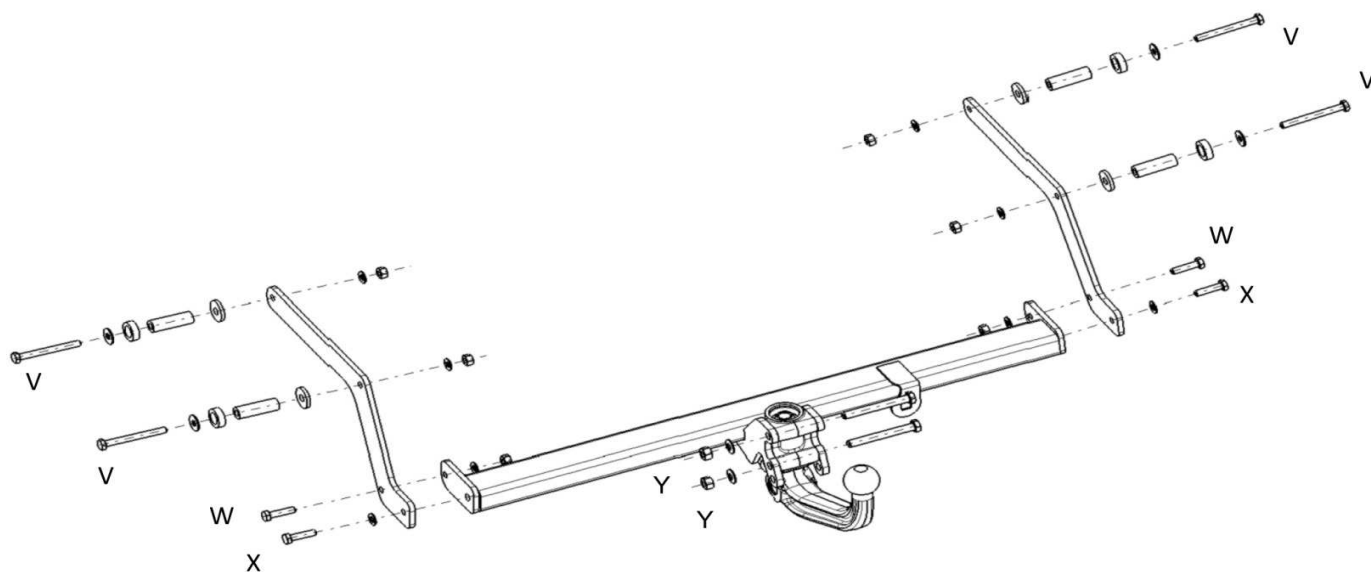





**316341**



<b>VISSERIE</b>		<b>QTÉ</b>
<b>V</b>	 HM10x95 - cl10.9 - 67Nm	x 4
	 Ø10,5/27	x 4
	 Ø 20/32 x 10	x 4
	 Ø 10,5/20 L=60	x 4
	 M10 - cl10	x 4
<b>W</b>	 HM10x40 - cl8.8 - 46Nm	x 2
	 CS10	x 2
	 M10 - cl10	x 2
<b>X</b>	 HM10x40 - cl8.8 - 46 Nm	x 2
	 CS10	x 2
<b>Y</b>	 HM12x60 - cl8.8 - 81 Nm	x 1
	 CS12	x 1
	 M12 - cl8	x 1
<b>Y'</b>	 HM12x60 - cl8.8 - 81 Nm	x1
	 CS12	x 1
	 M12 - cl8	x 1
	 D12	x 1

316342



VISSERIE		QTÉ
V	 HM10x95 - c110.9 - 67Nm	x 4
	 Ø10,5/27	x 4
	 Ø 20/32 x 10	x 4
	 Ø 10,5/20 L=60	x 4
	 M10 - c110	x 4
W	 HM10x40 - c18.8 - 46Nm	x 2
	 CS10	x 2
	 M10 - c110	x 2
X	 HM10x40 - c18.8 - 46Nm	x 2
	 CS10	x 2
Y	 HM12x100 - c110.9 - 116,5 Nm	x 2
	 CS12	x 2
	 M12 - c110	x 2

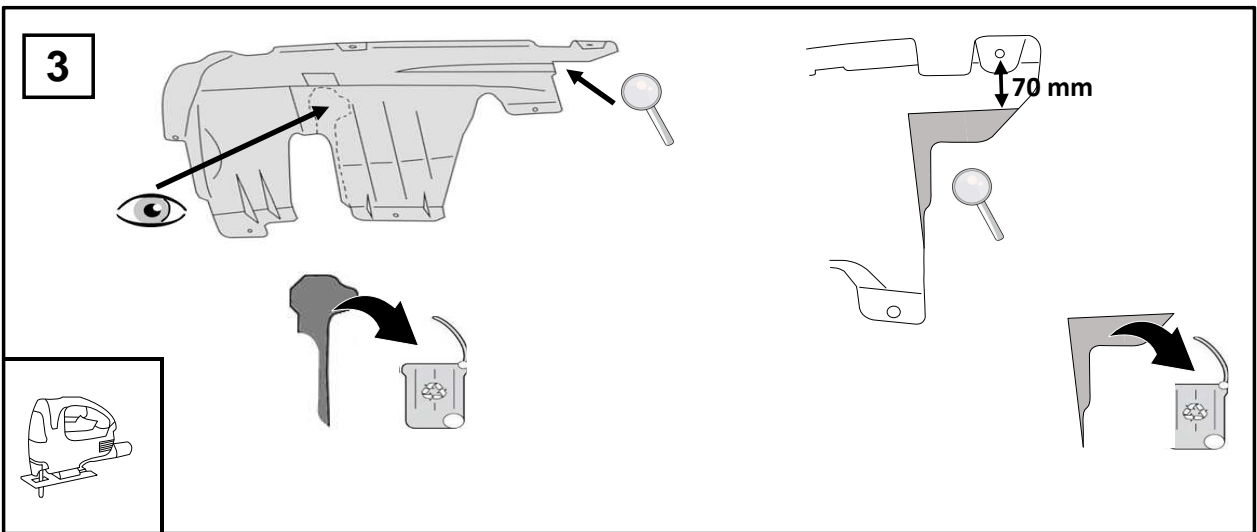
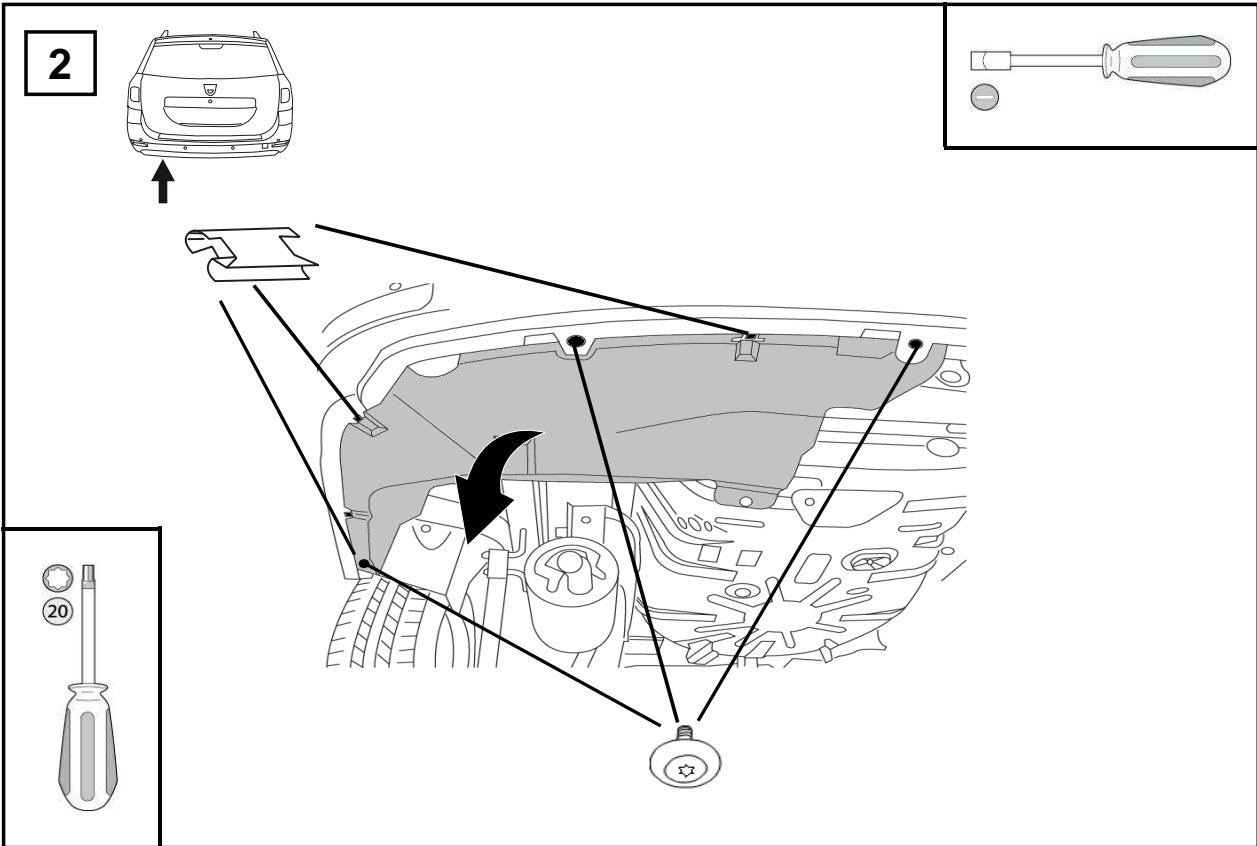
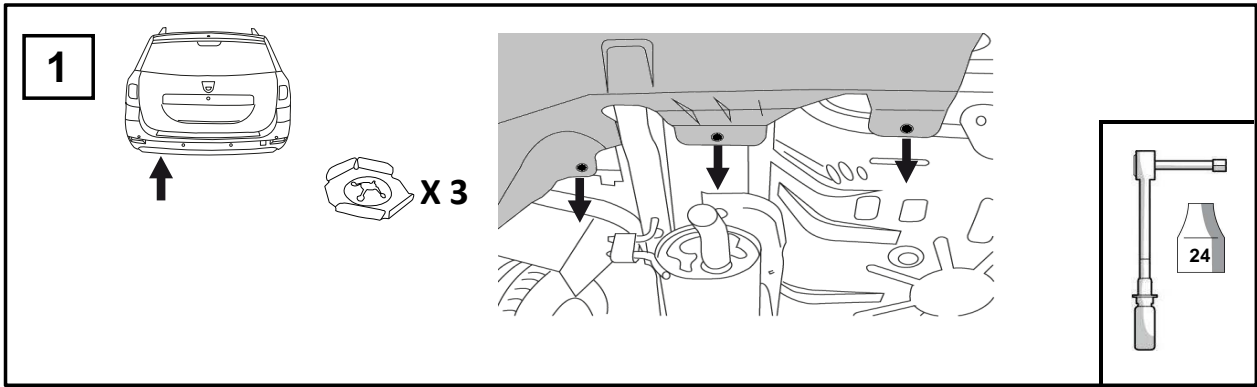

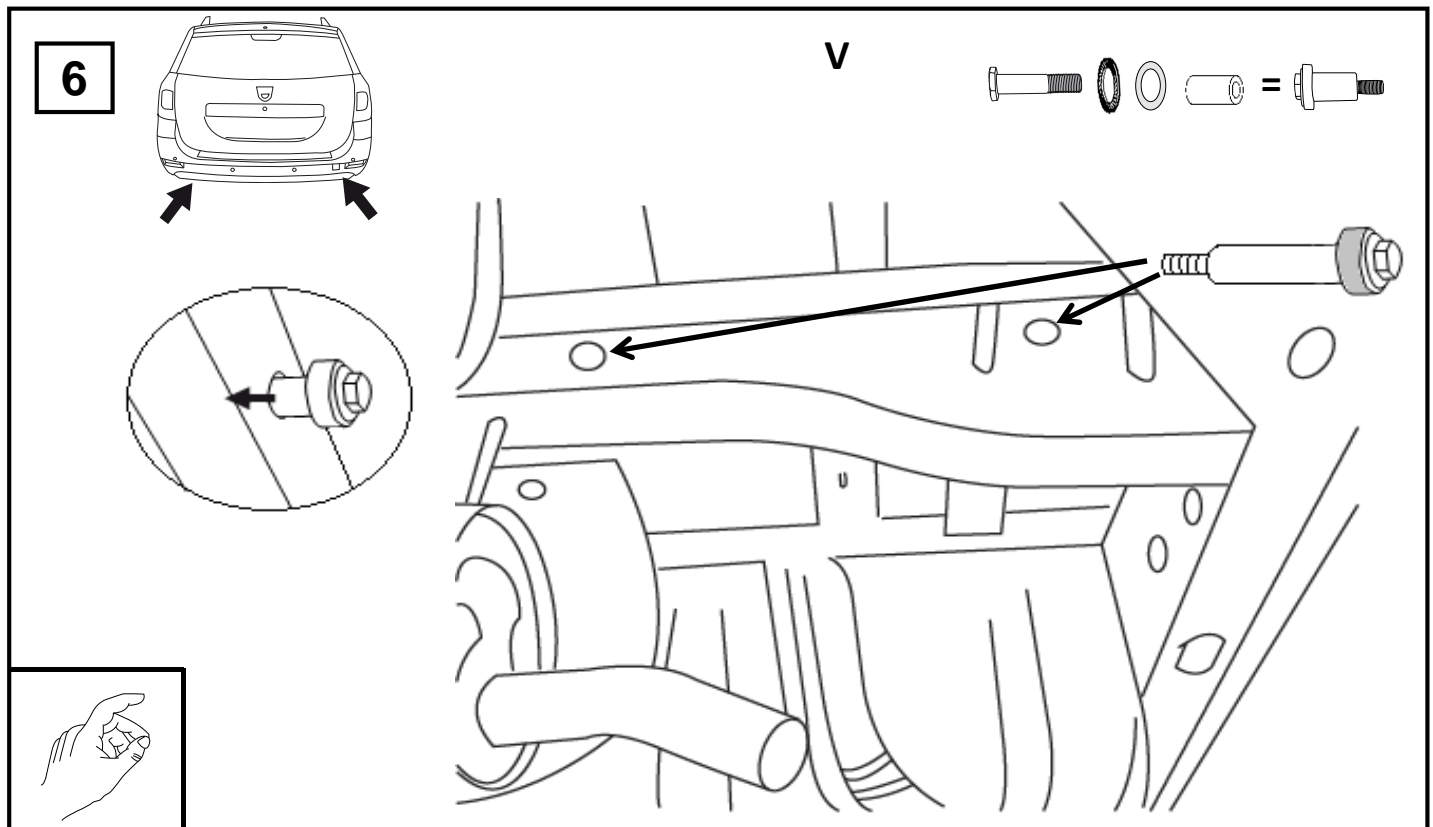
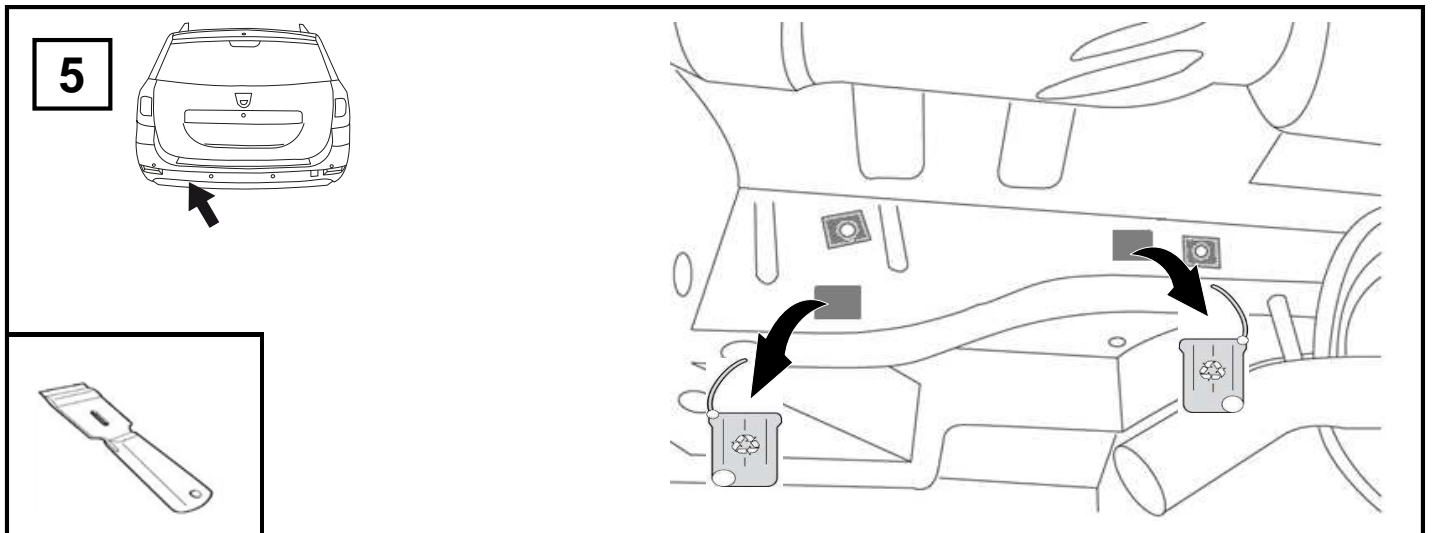
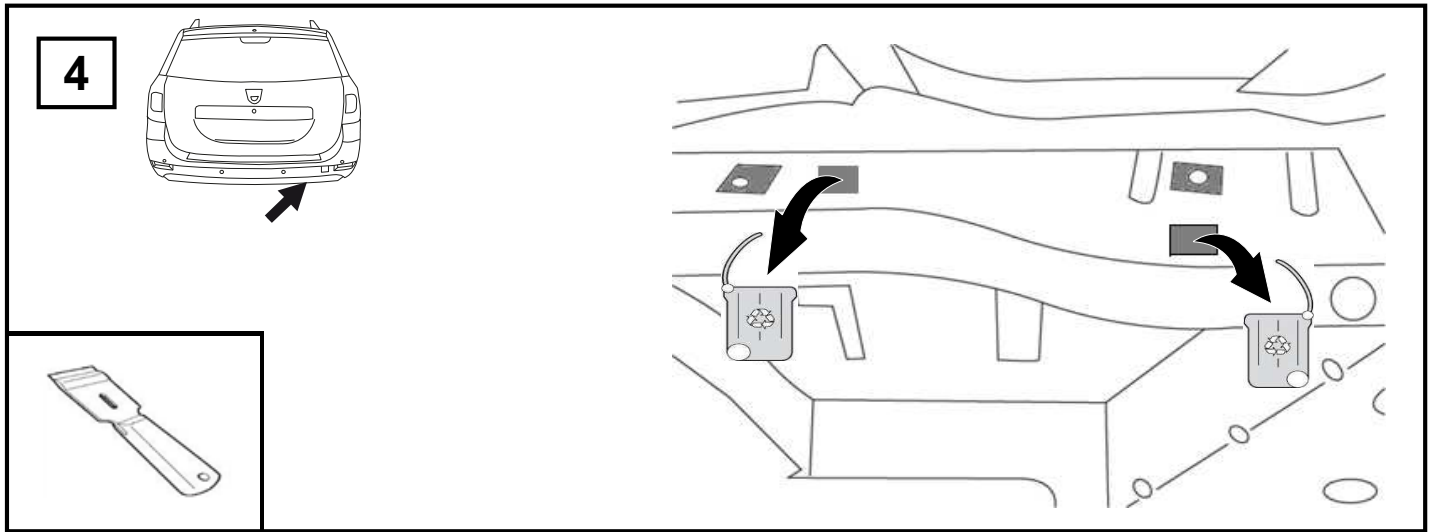

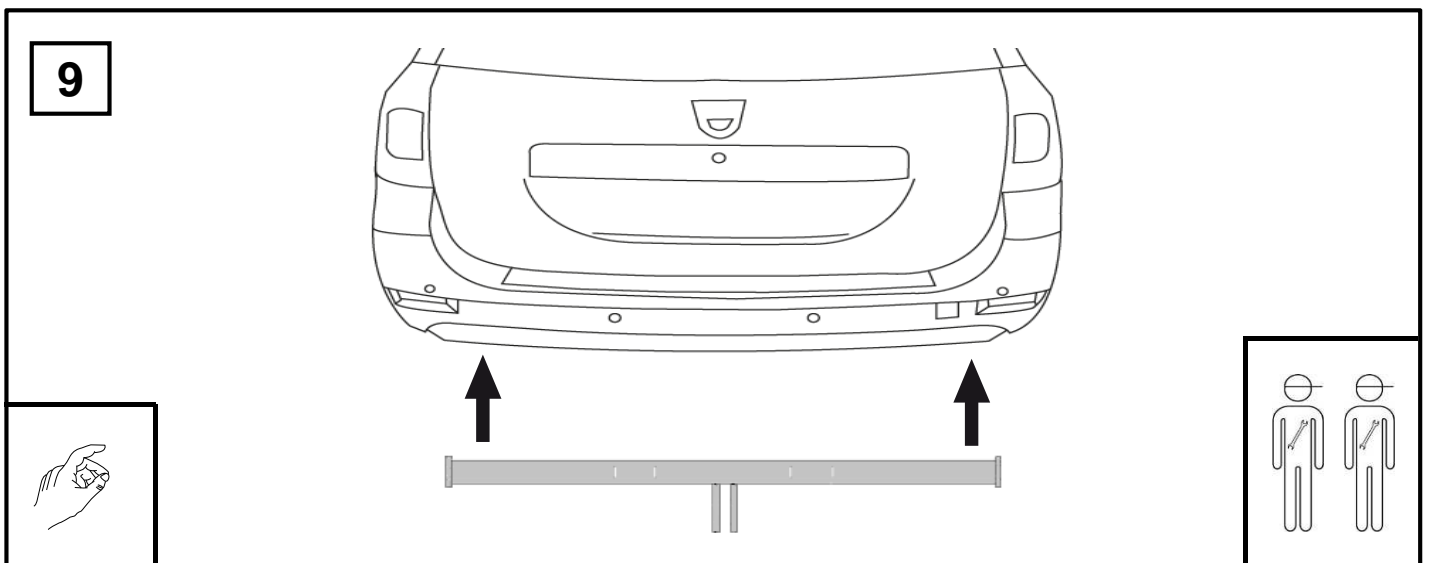
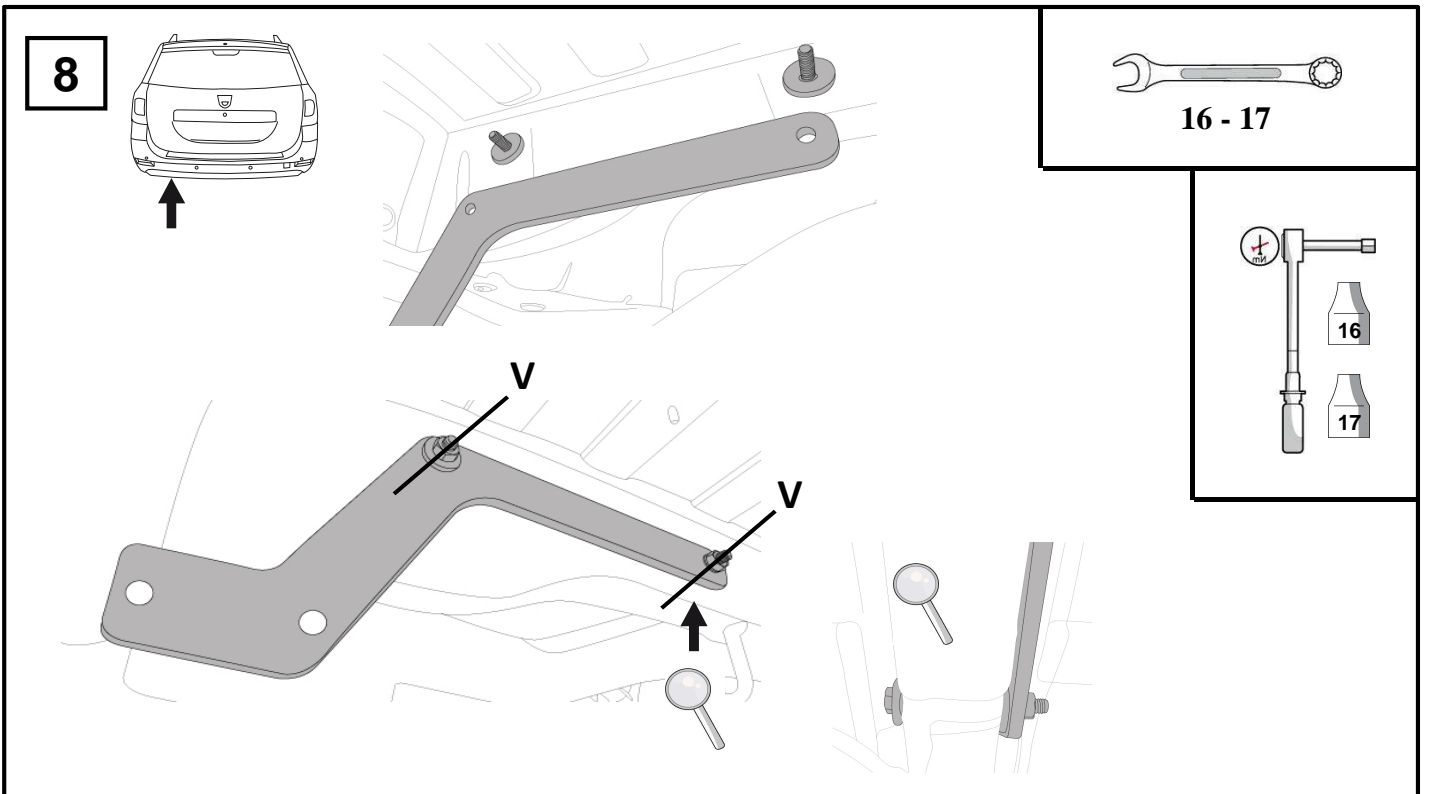
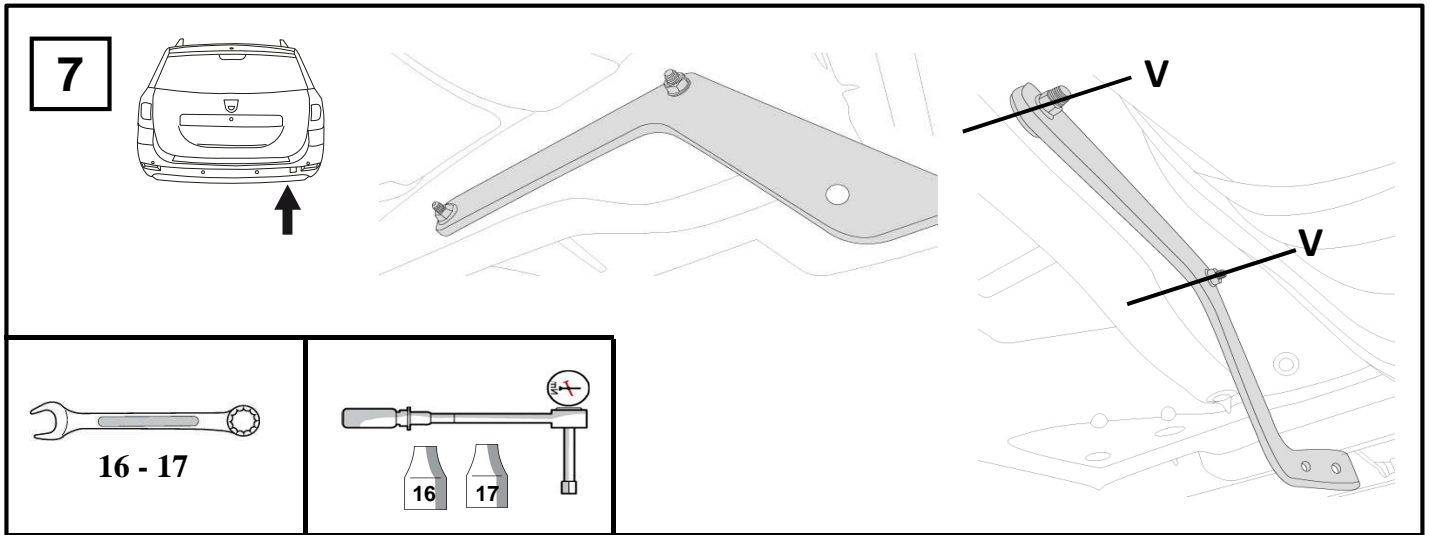

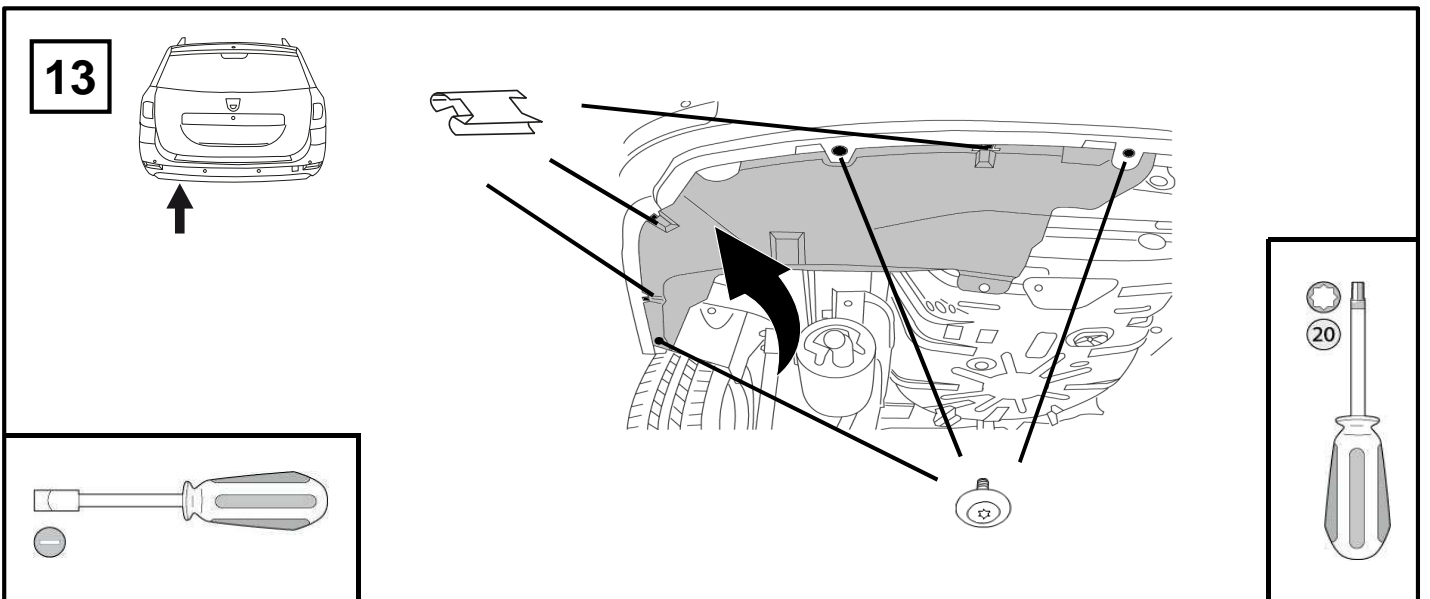
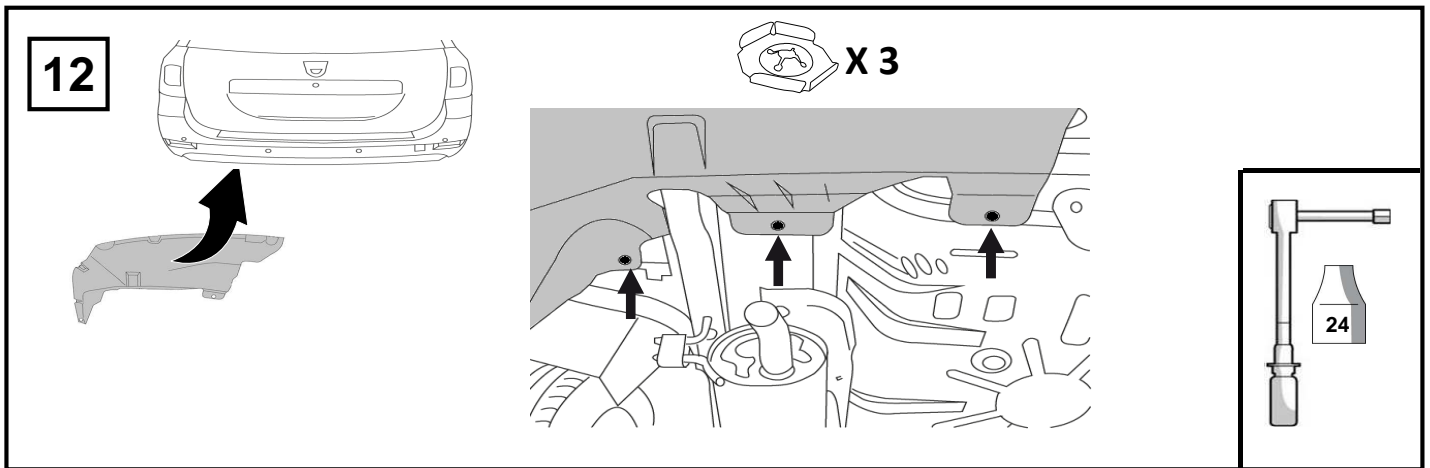
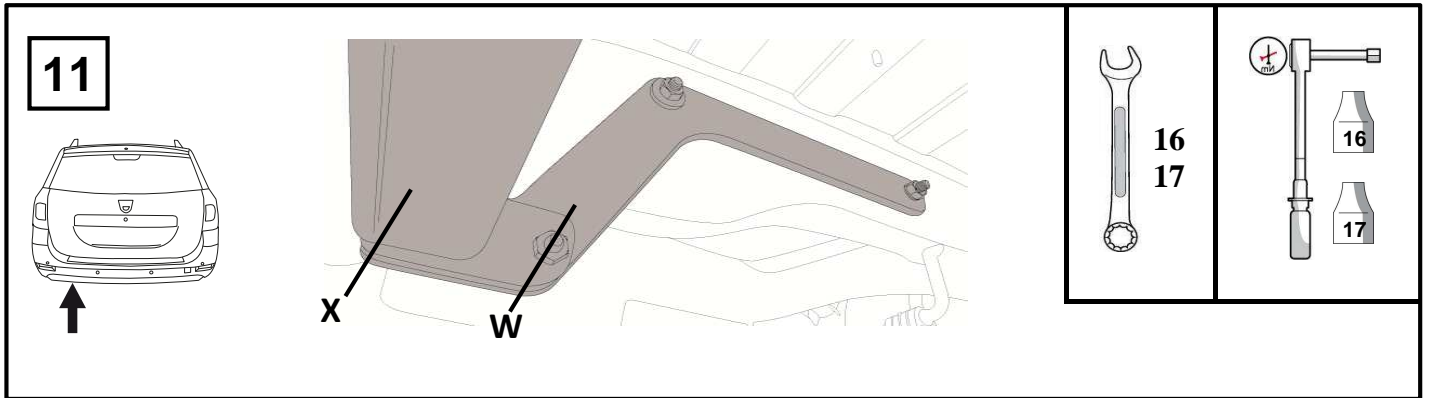
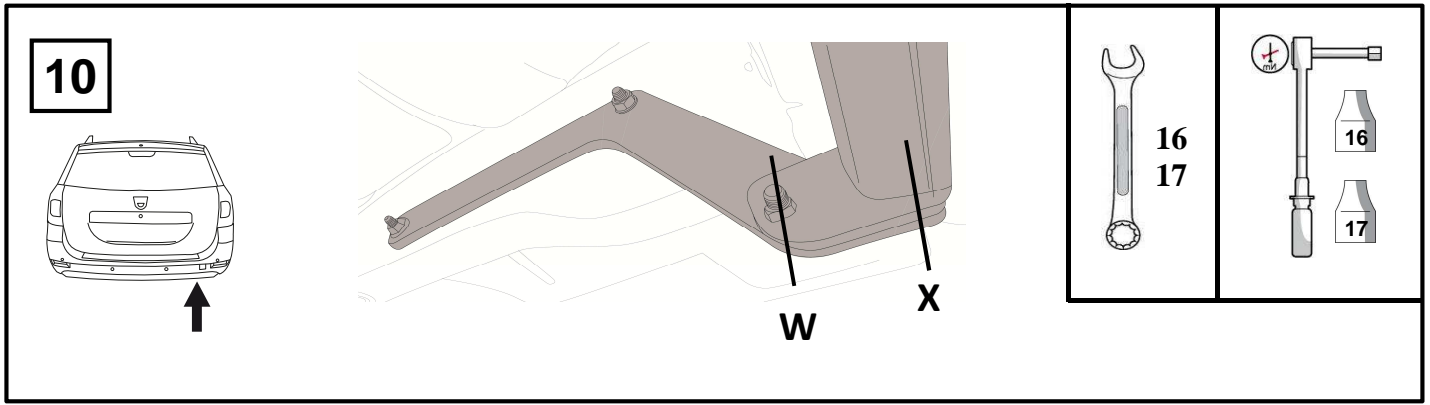

Dispositivo di traino tipo : **316341 / 316342**  
Per autoveicolo : **Dacia Logan MCV**  
Tipo funzionale : **SI217 / SI218**



Classe e tipo di attacco : **A50-X**  
Omologazione : **e24\*55R\*01\*0349 (316341) - e24\*55R\*01\*0350 (316342)**  
Valore D : **6,81 kN**  
Carico verticale max. S : **75 kg**  
Massa rimorchiabile : vedi carta di circolazione dell'autoveicolo

In base alla Direttiva europea 94/20, la massa massima rimorchiabile del dispositivo di traino è determinata dal valore di prova "D" così definito :

$$D = (T \times C) / (T + C) \times 0,00981 = 6,81 \text{ kN}$$

dove : T = Massa complessiva max. della motrice (in kg) e C = Massa rimorchiabile max. della motrice (in kg)

#### DICHIARAZIONE DI CORRETTO MONTAGGIO :

la sottoscritta Ditta dichiara che il dispositivo di traino tipo \_\_\_\_\_ è stato installato a regola d'arte, nel rispetto dei punti d'attacco e delle prescrizioni fornite dalla Casa costruttrice

sul veicolo Berlingo/Partner

targato \_\_\_\_\_

li \_\_\_\_\_

Si dichiara inoltre di aver informato l'utente del veicolo sull'USO e MANUTENZIONE del dispositivo stesso.

timbro et firma

